

FLKM 50/32P/PLC - Passive module



2291121

<https://www.phoenixcontact.com/us/products/2291121>

Please be informed that the data shown in this PDF document is generated from our online catalog. Please find the complete data in the user documentation. Our general terms of use for downloads are valid.

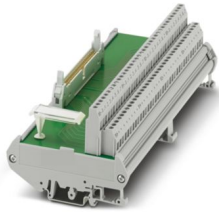

VARIOFACE interface module, for 32 channels, each with an additional terminal block per signal for a common plus potential

Your advantages

- Byte-by-byte labeling
- Can be used for all digital I/O modules

Commercial data

Item number	2291121
Packing unit	1 pc
Minimum order quantity	1 pc
Sales key	C421
Product key	CK2162
Catalog page	Page 519 (C-5-2019)
GTIN	4017918058265
Weight per piece (including packing)	410.866 g
Weight per piece (excluding packing)	300.96 g
Customs tariff number	85369010
Country of origin	DE

FLKM 50/32P/PLC - Passive module



2291121

<https://www.phoenixcontact.com/us/products/2291121>

Technical data

Product properties

Product type	Interface module
Product family	VARIOFACE
Number of positions	50
No. of channels	32

Insulation characteristics

Insulation	Functional insulation
------------	-----------------------

Insulation characteristics: Air clearances and creepage distances

Insulation	Functional insulation
Overvoltage category	II
Pollution degree	2

Electrical properties

Operating voltage (DC)	≤ 60 V DC
Current (per branch)	≤ 1 A
Current (Voltage supply)	≤ 8 A

Air clearances and creepage distances

Rated insulation voltage	63 V
Rated surge voltage	0.6 kV (1.2/50 μs)

Supported controller SIEMENS S7-1500

Suitable I/O card	6ES7521-1BL00-0AB0
	6ES7522-1BL00-0AB0
	6ES7522-1BL01-0AB0

Supported controller SIEMENS S7-400

Suitable I/O card	6ES7421-1BL01-0AA0
	6ES7422-1BL00-0AA0
	6ES7422-7BL00-0AB0

Supported controller ALLEN-BRADLEY ControlLogix

Suitable I/O card	1756-IB32
	1756-OB32

Supported controller ALLEN-BRADLEY PLC 5

Suitable I/O card	1771 IBN
	1771 OBN

Supported controller HONEYWELL Experion PKS C200

Suitable I/O card	TC-IDD 321
	TC-ODD 321

FLKM 50/32P/PLC - Passive module



2291121

<https://www.phoenixcontact.com/us/products/2291121>

Supported controller MITSUBISHI MELSEC L

Suitable I/O card	LX41C4
	LX42C4
	LY41NT1P
	LY42NT1P
	LY41PT1P
	LY42PT1P

Supported controller MITSUBISHI MELSEC Q

Suitable I/O card	QX81
	QY81P
	QX41
	QX41-S1
	QX42
	QX42-S1
	QX71
	QX72
	QY41P
	QY42P
	QY71
	QH42P
	QX82
	QX82-S1
	QY82P

Supported controller SCHNEIDER ELECTRIC Modicon TSX QUANTUM

Suitable I/O card	DDI 353
	DDI 853
	DAI 453
	DDO 353

Supported controller SIEMENS S7-300 / ET 200 M

Suitable I/O card	CPU 313C-2DP
	CPU 314C-2DP
	CPU 314C-2PtP
	6ES7321-1BL00-0AA0
	6ES7322-1BL00-0AA0
	6ES7323-1BL00-0AA0
	CPU 313C
	CPU 313C-2PtP

Supported controller GE-FANUC RX3i

Suitable I/O card	IC694MDL754
	IC694MDL660

Supported controller SIEMENS ET 200SP HA

FLKM 50/32P/PLC - Passive module



2291121

<https://www.phoenixcontact.com/us/products/2291121>

Suitable terminal block	6DL1193-6TP00-0BH1
	6DL1193-6TP00-0DH1
	6DL1193-6TP00-0BM1
	6DL1193-6TP00-0DM1
Suitable I/O module	6DL1131-6BL00-0PH1 (Terminal Block H1/M1)
	6DL1132-6BL00-0PH1 (Terminal Block H1/M1)

Connection data

Connection 1 (control level)

Connection in acc. with standard	IEC 60603-13
Connection method	IDC/FLK pin strip
Number of connections	1
Number of positions	50
Insertion/withdrawal cycles	> 50
Pitch	2.54 mm

Connection 2 (field level)

Connection method	Screw connection
Stripping length	8 mm
Screw thread	M3
Number of positions	72
Conductor cross section rigid	0.2 mm ² ... 4 mm ²
Conductor cross section flexible	0.2 mm ² ... 2.5 mm ²
Conductor cross section AWG	24 ... 12

Signaling

Status display present	No
------------------------	----

Dimensions

Item dimensions

Width	190.8 mm
Height	89.6 mm
Depth	65.9 mm

Material specifications

Color	gray (RAL 7042)
Housing insulation material	PVC

Environmental and real-life conditions

Ambient conditions

Degree of protection (Module)	IP00
Degree of protection (Installation location)	≥ IP54
Ambient temperature (operation)	-20 °C ... 50 °C
Ambient temperature (storage/transport)	-20 °C ... 70 °C

FLKM 50/32P/PLC - Passive module



2291121

<https://www.phoenixcontact.com/us/products/2291121>

Altitude	≤ 2000 m
----------	----------

Approvals

UKCA

Certificate	UKCA-compliant
-------------	----------------

Standards and regulations

Air clearances and creepage distances

Standards/regulations	EN IEC 60664-1
-----------------------	----------------

Mounting

Mounting type	DIN rail mounting
Mounting position	any

Notes

General	For proper use, the specifications of the installation directive (see Downloads) must be observed. For applications or use with third-party products, the specifications, and the safety and warning instructions of the respective third-party manufacturer must also be met.
---------	--

FLKM 50/32P/PLC - Passive module



2291121

<https://www.phoenixcontact.com/us/products/2291121>

Drawings

Circuit diagram

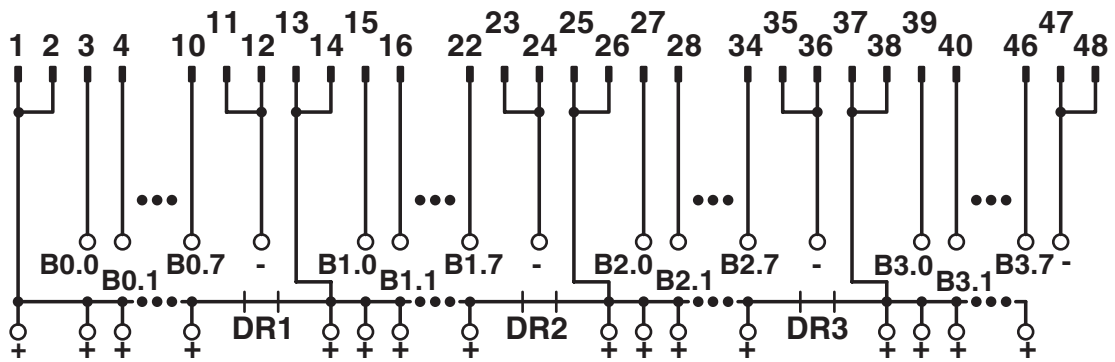

FLKM 50/32P/PLC - Passive module





2291121

<https://www.phoenixcontact.com/us/products/2291121>

Approvals

To download certificates, visit the product detail page: <https://www.phoenixcontact.com/us/products/2291121>

 cUL Recognized Approval ID: FILE E 238705				
	Nominal voltage U_N	Nominal current I_N	Cross section AWG	Cross section mm^2
	125 V	2 A	-	-

 UL Recognized Approval ID: FILE E 238705				
	Nominal voltage U_N	Nominal current I_N	Cross section AWG	Cross section mm^2
	125 V	2 A	-	-

cULus Recognized

FLKM 50/32P/PLC - Passive module



2291121

<https://www.phoenixcontact.com/us/products/2291121>

Classifications

ECLASS

ECLASS-11.0	27141152
ECLASS-12.0	27141152
ECLASS-13.0	27141152

ETIM

ETIM 9.0	EC002780
----------	----------

UNSPSC

UNSPSC 21.0	39121400
-------------	----------

FLKM 50/32P/PLC - Passive module



2291121

<https://www.phoenixcontact.com/us/products/2291121>

Environmental product compliance

EU RoHS

Fulfills EU RoHS substance requirements	Yes, No exemptions
---	--------------------

China RoHS

Environment friendly use period (EFUP)	EFUP-E
	No hazardous substances above the limits

EU REACH SVHC

REACH candidate substance (CAS No.)	No substance above 0.1 wt%
-------------------------------------	----------------------------

FLKM 50/32P/PLC - Passive module



2291121

<https://www.phoenixcontact.com/us/products/2291121>

Accessories

FLK 50/EZ-DR/ 50/KONFEK - Cable

2289065

<https://www.phoenixcontact.com/us/products/2289065>

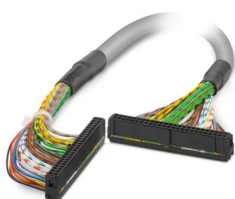

Round cable set; connection 1: IDC/FLK socket strip (1x 50-position); connection 2: IDC/FLK socket strip (1x 50-position); cable length: 0.5 m

FLK 50/EZ-DR/ 100/KONFEK - Cable

2289078

<https://www.phoenixcontact.com/us/products/2289078>

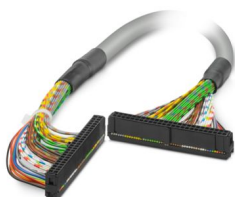

Round cable set; connection 1: IDC/FLK socket strip (1x 50-position); connection 2: IDC/FLK socket strip (1x 50-position); cable length: 1 m

FLKM 50/32P/PLC - Passive module



2291121

<https://www.phoenixcontact.com/us/products/2291121>

FLK 50/EZ-DR/ 150/KONFEK - Cable

2289081

<https://www.phoenixcontact.com/us/products/2289081>

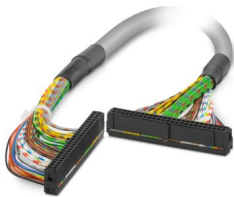

Round cable set; connection 1: IDC/FLK socket strip (1x 50-position); connection 2: IDC/FLK socket strip (1x 50-position); cable length: 1.5 m

FLK 50/EZ-DR/ 200/KONFEK - Cable

2289094

<https://www.phoenixcontact.com/us/products/2289094>



Round cable set; connection 1: IDC/FLK socket strip (1x 50-position); connection 2: IDC/FLK socket strip (1x 50-position); cable length: 2 m

FLKM 50/32P/PLC - Passive module

2291121

<https://www.phoenixcontact.com/us/products/2291121>

FLK 50/EZ-DR/ 250/KONFEK - Cable

2289104

<https://www.phoenixcontact.com/us/products/2289104>

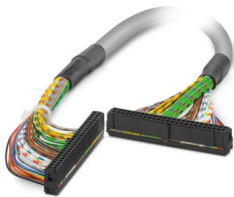

Round cable set; connection 1: IDC/FLK socket strip (1x 50-position); connection 2: IDC/FLK socket strip (1x 50-position); cable length: 2.5 m

FLK 50/EZ-DR/ 300/KONFEK - Cable

2289117

<https://www.phoenixcontact.com/us/products/2289117>



Round cable set; connection 1: IDC/FLK socket strip (1x 50-position); connection 2: IDC/FLK socket strip (1x 50-position); cable length: 3 m

FLKM 50/32P/PLC - Passive module

2291121

<https://www.phoenixcontact.com/us/products/2291121>

FLK 50/EZ-DR/ 350/KONFEK - Cable

2289120

<https://www.phoenixcontact.com/us/products/2289120>

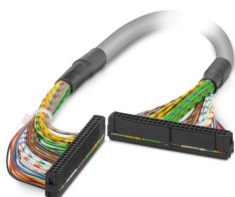

Round cable set; connection 1: IDC/FLK socket strip (1x 50-position); connection 2: IDC/FLK socket strip (1x 50-position); cable length: 3.5 m

FLK 50/EZ-DR/ 400/KONFEK - Cable

2289133

<https://www.phoenixcontact.com/us/products/2289133>

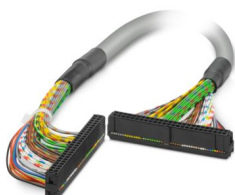

Round cable set; connection 1: IDC/FLK socket strip (1x 50-position); connection 2: IDC/FLK socket strip (1x 50-position); cable length: 4 m

FLKM 50/32P/PLC - Passive module



2291121

<https://www.phoenixcontact.com/us/products/2291121>

FLK 50/EZ-DR/ 450/KONFEK - Cable

2289573

<https://www.phoenixcontact.com/us/products/2289573>

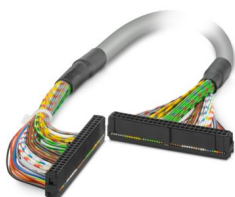

Round cable set; connection 1: IDC/FLK socket strip (1x 50-position); connection 2: IDC/FLK socket strip (1x 50-position); cable length: 4.5 m

FLK 50/EZ-DR/ 500/KONFEK - Cable

2289586

<https://www.phoenixcontact.com/us/products/2289586>

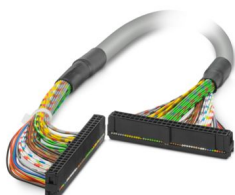

Round cable set; connection 1: IDC/FLK socket strip (1x 50-position); connection 2: IDC/FLK socket strip (1x 50-position); cable length: 5 m

FLKM 50/32P/PLC - Passive module

2291121

<https://www.phoenixcontact.com/us/products/2291121>

FLK 50/EZ-DR/ 550/KONFEK - Cable

2289599

<https://www.phoenixcontact.com/us/products/2289599>



Round cable set; connection 1: IDC/FLK socket strip (1x 50-position); connection 2: IDC/FLK socket strip (1x 50-position); cable length: 5.5 m

FLK 50/EZ-DR/ 600/KONFEK - Cable

2289609

<https://www.phoenixcontact.com/us/products/2289609>



Round cable set; connection 1: IDC/FLK socket strip (1x 50-position); connection 2: IDC/FLK socket strip (1x 50-position); cable length: 6 m

FLKM 50/32P/PLC - Passive module

2291121

<https://www.phoenixcontact.com/us/products/2291121>

FLK 50/EZ-DR/ 700/KONFEK - Cable

2289625

<https://www.phoenixcontact.com/us/products/2289625>

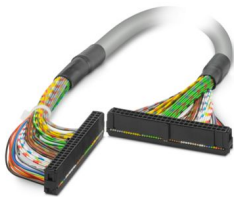

Round cable set; connection 1: IDC/FLK socket strip (1x 50-position); connection 2: IDC/FLK socket strip (1x 50-position); cable length: 7 m

FLK 50/EZ-DR/ 750/KONFEK - Cable

2289638

<https://www.phoenixcontact.com/us/products/2289638>



Round cable set; connection 1: IDC/FLK socket strip (1x 50-position); connection 2: IDC/FLK socket strip (1x 50-position); cable length: 7.5 m

FLKM 50/32P/PLC - Passive module



2291121

<https://www.phoenixcontact.com/us/products/2291121>

FLK 50/EZ-DR/ 800/KONFEK - Cable

2289641

<https://www.phoenixcontact.com/us/products/2289641>

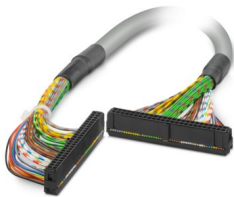

Round cable set; connection 1: IDC/FLK socket strip (1x 50-position); connection 2: IDC/FLK socket strip (1x 50-position); cable length: 8 m

FLK 50/EZ-DR/ 850/KONFEK - Cable

2289654

<https://www.phoenixcontact.com/us/products/2289654>



Round cable set; connection 1: IDC/FLK socket strip (1x 50-position); connection 2: IDC/FLK socket strip (1x 50-position); cable length: 8.5 m

FLKM 50/32P/PLC - Passive module

2291121

<https://www.phoenixcontact.com/us/products/2291121>

FLK 50/EZ-DR/ 900/KONFEK - Cable

2289667

<https://www.phoenixcontact.com/us/products/2289667>



Round cable set; connection 1: IDC/FLK socket strip (1x 50-position); connection 2: IDC/FLK socket strip (1x 50-position); cable length: 9 m

FLK 50/EZ-DR/1000/KONFEK - Cable

2289683

<https://www.phoenixcontact.com/us/products/2289683>



Round cable set; connection 1: IDC/FLK socket strip (1x 50-position); connection 2: IDC/FLK socket strip (1x 50-position); cable length: 10 m

FLKM 50/32P/PLC - Passive module

2291121

<https://www.phoenixcontact.com/us/products/2291121>

FLK 50/EZ-DR/ 125/KONFEK - Cable

2296197

<https://www.phoenixcontact.com/us/products/2296197>



Round cable set; connection 1: IDC/FLK socket strip (1x 50-position); connection 2: IDC/FLK socket strip (1x 50-position); cable length: 1.25 m

FLK 50/EZ-DR/1200/KONFEK - Cable

2296223

<https://www.phoenixcontact.com/us/products/2296223>

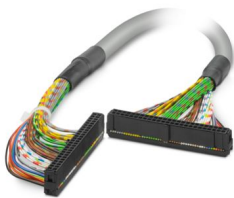

Round cable set; connection 1: IDC/FLK socket strip (1x 50-position); connection 2: IDC/FLK socket strip (1x 50-position); cable length: 12 m

FLKM 50/32P/PLC - Passive module



2291121

<https://www.phoenixcontact.com/us/products/2291121>

FLK 50/EZ-DR/ 50/KONFEK/S - Cable

2299097

<https://www.phoenixcontact.com/us/products/2299097>



Assembled shielded round cable; connection 1: IDC/FLK socket strip (1x 50-position); connection 2: IDC/FLK socket strip (1x 50-position) (The braided shield is routed to a separate cable end.); cable length: 0.5 m

FLK 50/EZ-DR/ 100/KONFEK/S - Cable

2299107

<https://www.phoenixcontact.com/us/products/2299107>



Assembled shielded round cable; connection 1: IDC/FLK socket strip (1x 50-position); connection 2: IDC/FLK socket strip (1x 50-position) (The braided shield is routed to a separate cable end.); cable length: 1 m

FLKM 50/32P/PLC - Passive module



2291121

<https://www.phoenixcontact.com/us/products/2291121>

FLK 50/EZ-DR/ 150/KONFEK/S - Cable

2299110

<https://www.phoenixcontact.com/us/products/2299110>



Assembled shielded round cable; connection 1: IDC/FLK socket strip (1x 50-position); connection 2: IDC/FLK socket strip (1x 50-position) (The braided shield is routed to a separate cable end.); cable length: 1.5 m

FLK 50/EZ-DR/ 200/KONFEK/S - Cable

2299123

<https://www.phoenixcontact.com/us/products/2299123>



Assembled shielded round cable; connection 1: IDC/FLK socket strip (1x 50-position); connection 2: IDC/FLK socket strip (1x 50-position) (The braided shield is routed to a separate cable end.); cable length: 2 m

FLKM 50/32P/PLC - Passive module

2291121

<https://www.phoenixcontact.com/us/products/2291121>



FLK 50/EZ-DR/ 300/KONFEK/S - Cable

2299136

<https://www.phoenixcontact.com/us/products/2299136>



Assembled shielded round cable; connection 1: IDC/FLK socket strip (1x 50-position); connection 2: IDC/FLK socket strip (1x 50-position) (The braided shield is routed to a separate cable end.); cable length: 3 m

FLK 50/EZ-DR/ 400/KONFEK/S - Cable

2299149

<https://www.phoenixcontact.com/us/products/2299149>



Assembled shielded round cable; connection 1: IDC/FLK socket strip (1x 50-position); connection 2: IDC/FLK socket strip (1x 50-position) (The braided shield is routed to a separate cable end.); cable length: 4 m

FLKM 50/32P/PLC - Passive module

2291121

<https://www.phoenixcontact.com/us/products/2291121>



FLK 50/EZ-DR/ 600/KONFEK/S - Cable

2299152

<https://www.phoenixcontact.com/us/products/2299152>



Assembled shielded round cable; connection 1: IDC/FLK socket strip (1x 50-position); connection 2: IDC/FLK socket strip (1x 50-position) (The braided shield is routed to a separate cable end.); cable length: 6 m

FLK 50/EZ-DR/1000/KONFEK/S - Cable

2299178

<https://www.phoenixcontact.com/us/products/2299178>



Assembled shielded round cable; connection 1: IDC/FLK socket strip (1x 50-position); connection 2: IDC/FLK socket strip (1x 50-position) (The braided shield is routed to a separate cable end.); cable length: 10 m

FLKM 50/32P/PLC - Passive module

2291121

<https://www.phoenixcontact.com/us/products/2291121>

CABLE-FLK50/0,14/HF/ 0,5M - Cable

2314134

<https://www.phoenixcontact.com/us/products/2314134>

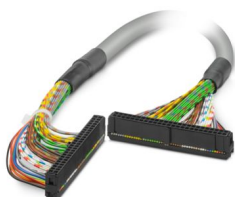

Assembled, halogen-free round cable; connection 1: IDC/FLK socket strip (1x 50-position); connection 2: IDC/FLK socket strip (1x 50-position); cable length: 0.5 m

CABLE-FLK50/0,14/HF/ 1,0M - Cable

2314147

<https://www.phoenixcontact.com/us/products/2314147>

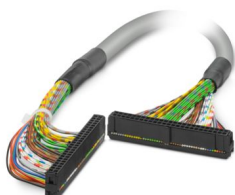

Assembled, halogen-free round cable; connection 1: IDC/FLK socket strip (1x 50-position); connection 2: IDC/FLK socket strip (1x 50-position); cable length: 1 m

FLKM 50/32P/PLC - Passive module

2291121

<https://www.phoenixcontact.com/us/products/2291121>

CABLE-FLK50/0,14/HF/ 1,5M - Cable

2314150

<https://www.phoenixcontact.com/us/products/2314150>

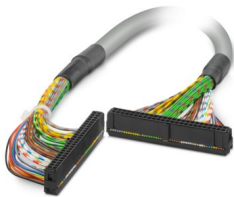

Assembled, halogen-free round cable; connection 1: IDC/FLK socket strip (1x 50-position); connection 2: IDC/FLK socket strip (1x 50-position); cable length: 1.5 m

CABLE-FLK50/0,14/HF/ 2,0M - Cable

2314163

<https://www.phoenixcontact.com/us/products/2314163>



Assembled, halogen-free round cable; connection 1: IDC/FLK socket strip (1x 50-position); connection 2: IDC/FLK socket strip (1x 50-position); cable length: 2 m

FLKM 50/32P/PLC - Passive module

2291121

<https://www.phoenixcontact.com/us/products/2291121>

CABLE-FLK50/0,14/HF/ 2,5M - Cable

2314176

<https://www.phoenixcontact.com/us/products/2314176>

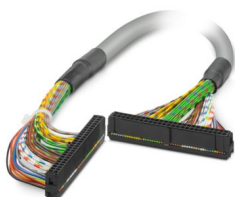

Assembled, halogen-free round cable; connection 1: IDC/FLK socket strip (1x 50-position); connection 2: IDC/FLK socket strip (1x 50-position); cable length: 2.5 m

CABLE-FLK50/0,14/HF/ 3,0M - Cable

2314189

<https://www.phoenixcontact.com/us/products/2314189>

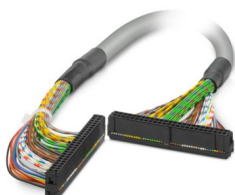

Assembled, halogen-free round cable; connection 1: IDC/FLK socket strip (1x 50-position); connection 2: IDC/FLK socket strip (1x 50-position); cable length: 3 m

FLKM 50/32P/PLC - Passive module

2291121

<https://www.phoenixcontact.com/us/products/2291121>

CABLE-FLK50/0,14/HF/ 4,0M - Cable

2314192

<https://www.phoenixcontact.com/us/products/2314192>



Assembled, halogen-free round cable; connection 1: IDC/FLK socket strip (1x 50-position); connection 2: IDC/FLK socket strip (1x 50-position); cable length: 4 m

CABLE-FLK50/0,14/HF/ 5,0M - Cable

2314202

<https://www.phoenixcontact.com/us/products/2314202>

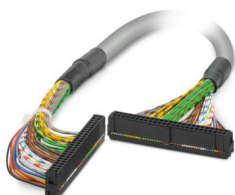

Assembled, halogen-free round cable; connection 1: IDC/FLK socket strip (1x 50-position); connection 2: IDC/FLK socket strip (1x 50-position); cable length: 5 m

FLKM 50/32P/PLC - Passive module

2291121

<https://www.phoenixcontact.com/us/products/2291121>

CABLE-FLK50/0,14/HF/10,0M - Cable

2314244

<https://www.phoenixcontact.com/us/products/2314244>

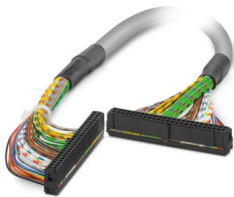

Assembled, halogen-free round cable; connection 1: IDC/FLK socket strip (1x 50-position); connection 2: IDC/FLK socket strip (1x 50-position); cable length: 10 m

CABLE-FLK50-0,14-HF/... - Cable

2314257

<https://www.phoenixcontact.com/us/products/2314257>



Assembled, halogen-free round cable; connection 1: IDC/FLK socket strip (1x 50-position); connection 2: IDC/FLK socket strip (1x 50-position); cable length: variable

FLKM 50/32P/PLC - Passive module

2291121

<https://www.phoenixcontact.com/us/products/2291121>

FLK 50/4X14/EZ-DR/ 50/KONFEK - Cable

2296689

<https://www.phoenixcontact.com/us/products/2296689>



Round cable set; connection 1: IDC/FLK socket strip (1x 50-position); connection 2: IDC/FLK socket strip (4x 14-position); cable length: 0.5 m

FLK 50/4X14/EZ-DR/ 100/KONFEK - Cable

2296692

<https://www.phoenixcontact.com/us/products/2296692>



Round cable set; connection 1: IDC/FLK socket strip (1x 50-position); connection 2: IDC/FLK socket strip (4x 14-position); cable length: 1 m

FLKM 50/32P/PLC - Passive module

2291121

<https://www.phoenixcontact.com/us/products/2291121>

FLK 50/4X14/EZ-DR/ 150/KONFEK - Cable

2296702

<https://www.phoenixcontact.com/us/products/2296702>



Round cable set; connection 1: IDC/FLK socket strip (1x 50-position); connection 2: IDC/FLK socket strip (4x 14-position); cable length: 1.5 m

FLK 50/4X14/EZ-DR/ 200/KONFEK - Cable

2296715

<https://www.phoenixcontact.com/us/products/2296715>



Round cable set; connection 1: IDC/FLK socket strip (1x 50-position); connection 2: IDC/FLK socket strip (4x 14-position); cable length: 2 m

FLKM 50/32P/PLC - Passive module



2291121

<https://www.phoenixcontact.com/us/products/2291121>

FLK 50/4X14/EZ-DR/ 250/KONFEK - Cable

2305402

<https://www.phoenixcontact.com/us/products/2305402>



Round cable set; connection 1: IDC/FLK socket strip (1x 50-position); connection 2: IDC/FLK socket strip (4x 14-position); cable length: 2.5 m

FLK 50/4X14/EZ-DR/ 300/KONFEK - Cable

2296728

<https://www.phoenixcontact.com/us/products/2296728>



Round cable set; connection 1: IDC/FLK socket strip (1x 50-position); connection 2: IDC/FLK socket strip (4x 14-position); cable length: 3 m

FLKM 50/32P/PLC - Passive module

2291121

<https://www.phoenixcontact.com/us/products/2291121>

FLK 50/4X14/EZ-DR/ 400/KONFEK - Cable

2296731

<https://www.phoenixcontact.com/us/products/2296731>



Round cable set; connection 1: IDC/FLK socket strip (1x 50-position); connection 2: IDC/FLK socket strip (4x 14-position); cable length: 4 m

FLK 50/4X14/EZ-DR/ 600/KONFEK - Cable

2296744

<https://www.phoenixcontact.com/us/products/2296744>



Round cable set; connection 1: IDC/FLK socket strip (1x 50-position); connection 2: IDC/FLK socket strip (4x 14-position); cable length: 6 m

FLKM 50/32P/PLC - Passive module

2291121

<https://www.phoenixcontact.com/us/products/2291121>



FLK 50/4X14/EZ-DR/1000/KONFEK - Cable

2296773

<https://www.phoenixcontact.com/us/products/2296773>



Round cable set; connection 1: IDC/FLK socket strip (1x 50-position); connection 2: IDC/FLK socket strip (4x 14-position); cable length: 10 m

FLK 50-4X14-EZ-DR ... - Cable

2302405

<https://www.phoenixcontact.com/us/products/2302405>



Round cable set; connection 1: IDC/FLK socket strip (1x 50-position); connection 2: IDC/FLK socket strip (4x 14-position); cable length: variable

FLKM 50/32P/PLC - Passive module

2291121

<https://www.phoenixcontact.com/us/products/2291121>



FLK 50-4X14-EZ-DR-S ... - Cable

2302447

<https://www.phoenixcontact.com/us/products/2302447>



Assembled shielded round cable; connection 1: IDC/FLK socket strip (1x 50-position); connection 2: IDC/FLK socket strip (4x 14-position) (The braided shield is routed to four separate cable ends.); cable length: variable

Phoenix Contact 2024 © - all rights reserved

<https://www.phoenixcontact.com>

Phoenix Contact USA
586 Fulling Mill Road
Middletown, PA 17057, United States
(+717) 944-1300
info@phoenixcon.com