

FLKM 50-PA/SC/DIO/S7-1500 - Front adapter



2907383

<https://www.phoenixcontact.com/us/products/2907383>

Please be informed that the data shown in this PDF document is generated from our online catalog. Please find the complete data in the user documentation. Our general terms of use for downloads are valid.



VARIOFACE front adapter with screw connection, for SIMATIC® S7-1500 digital 35 mm modules, 1x 32 channels can be connected.

Commercial data

Item number	2907383
Packing unit	1 pc
Minimum order quantity	1 pc
Sales key	C421
Product key	CK231S
Catalog page	Page 492 (C-5-2019)
GTIN	4055626256542
Weight per piece (including packing)	92.6 g
Weight per piece (excluding packing)	92.6 g
Customs tariff number	85369010
Country of origin	RO

FLKM 50-PA/SC/DIO/S7-1500 - Front adapter



2907383

<https://www.phoenixcontact.com/us/products/2907383>

Technical data

Product properties

Product type	Front adapter
--------------	---------------

Insulation characteristics

Overvoltage category	II
Pollution degree	2

Electrical properties

Max. permissible operating voltage	< 50 V DC
Max. permissible current	1 A (per path)
Max. permissible total current	2 A (per byte when supplying from the module side) 12 A (When supplying via the front adapter)
Nominal operating mode	100% operating factor
Rated surge voltage	0.5 kV

Supported controller SIEMENS S7-1500

Suitable I/O card	6ES7521-1BL00-0AB0
	6ES7522-1BL00-0AB0
	6ES7522-1BL01-0AB0

Connection data

Field level

Connection method	IDC/FLK pin strip
Number of connections	1
Number of positions	50
Pitch	2.54 mm

Supply

Connection method	Screw connection
Tightening torque	0.4 Nm

Dimensions

Item dimensions

Width	29.8 mm
Height	130.4 mm
Depth	46 mm

Environmental and real-life conditions

Ambient conditions

Degree of protection	IP20
Ambient temperature (operation)	-25 °C ... 60 °C
Ambient temperature (storage/transport)	-40 °C ... 70 °C

FLKM 50-PA/SC/DIO/S7-1500 - Front adapter



2907383

<https://www.phoenixcontact.com/us/products/2907383>

Standards and regulations

Standards/regulations	IEC 61131-2
-----------------------	-------------

Notes

Notes on operation	For proper use, the specifications of the installation directive (see Downloads) must be observed. For applications or use with third-party products, the specifications, and the safety and warning instructions of the respective third-party manufacturer must also be met.
--------------------	--

FLKM 50-PA/SC/DIO/S7-1500 - Front adapter



2907383

<https://www.phoenixcontact.com/us/products/2907383>

Drawings

Circuit diagram

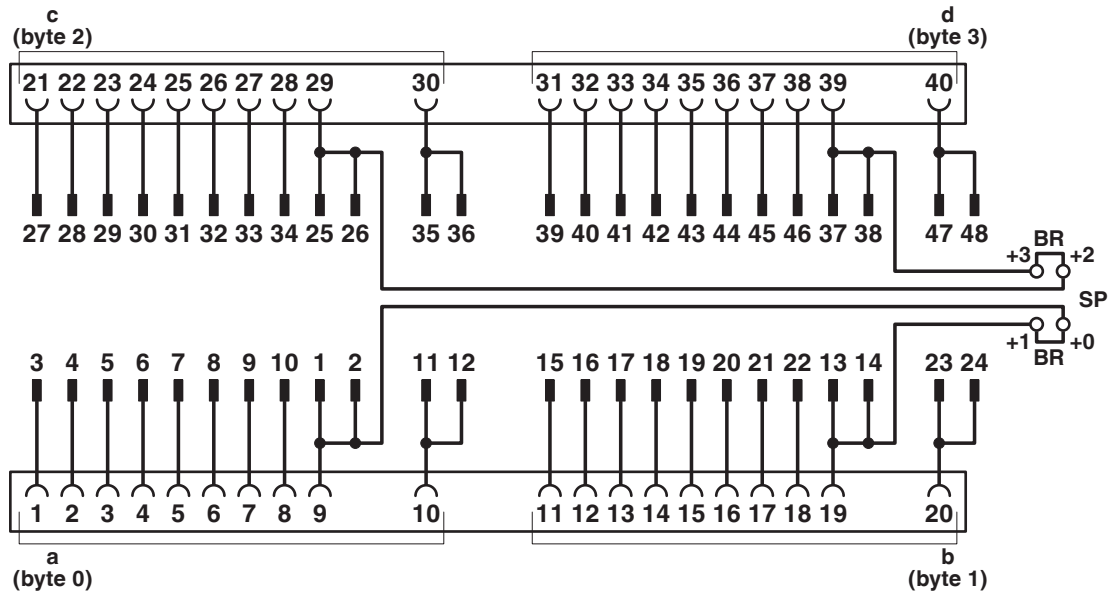

FLKM 50-PA/SC/DIO/S7-1500 - Front adapter



2907383

<https://www.phoenixcontact.com/us/products/2907383>

Approvals

To download certificates, visit the product detail page: <https://www.phoenixcontact.com/us/products/2907383>



EAC

Approval ID: RU C-DE.A*30.B00767



UL Listed

Approval ID: FILE E 238705



cUL Listed

Approval ID: FILE E 238705

cULus Listed

FLKM 50-PA/SC/DIO/S7-1500 - Front adapter



2907383

<https://www.phoenixcontact.com/us/products/2907383>

Classifications

ECLASS

ECLASS-12.0	27242292
ECLASS-11.0	27242292
ECLASS-13.0	27242292

ETIM

ETIM 9.0	EC002584
----------	----------

UNSPSC

UNSPSC 21.0	32151600
-------------	----------

FLKM 50-PA/SC/DIO/S7-1500 - Front adapter



2907383

<https://www.phoenixcontact.com/us/products/2907383>

Environmental product compliance

EU RoHS

Fulfills EU RoHS substance requirements	Yes, No exemptions
---	--------------------

China RoHS

Environment friendly use period (EFUP)	EFUP-50
	An article-related China RoHS declaration table can be found in the download area for the respective article under "Manufacturer declaration". For all articles with EFUP-E, no China RoHS declaration table issued and required.

EU REACH SVHC

REACH candidate substance (CAS No.)	No substance above 0.1 wt%
-------------------------------------	----------------------------

FLKM 50-PA/SC/DIO/S7-1500 - Front adapter

2907383

<https://www.phoenixcontact.com/us/products/2907383>



Accessories

VIP-2/SC/FLK50/PLC - Passive module

2315227

<https://www.phoenixcontact.com/us/products/2315227>

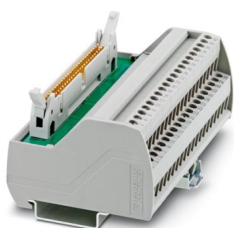

VARIOFACE interface module for 32 channels

VIP-2/PT/FLK50/PLC - Passive module

2903803

<https://www.phoenixcontact.com/us/products/2903803>

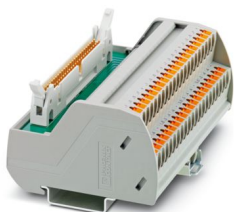

VARIOFACE interface module, with push-in connection, for 32 channels

FLKM 50-PA/SC/DIO/S7-1500 - Front adapter

2907383

<https://www.phoenixcontact.com/us/products/2907383>



VIP-2/SC/FLK50/LED/PLC - Passive module

2322252

<https://www.phoenixcontact.com/us/products/2322252>

VARIOFACE interface module, with LED, for 32 channels



VIP-2/PT/FLK50/LED/PLC - Passive module

2904280

<https://www.phoenixcontact.com/us/products/2904280>

VARIOFACE interface module, with push-in connection and light indicator, for 32 channels



FLKM 50-PA/SC/DIO/S7-1500 - Front adapter

2907383

<https://www.phoenixcontact.com/us/products/2907383>



FLKMS 50/32IM/LA/PLC - Passive module

2284510

<https://www.phoenixcontact.com/us/products/2284510>

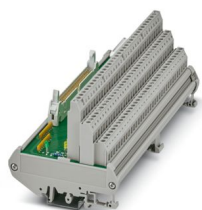

VARIOFACE sensor module, for connecting 32 p-n-p sensors, with LED

VIP-2/SC/FLK14/PLC - Passive module

2315214

<https://www.phoenixcontact.com/us/products/2315214>



VARIOFACE interface module for 8 channels

FLKM 50-PA/SC/DIO/S7-1500 - Front adapter



2907383

<https://www.phoenixcontact.com/us/products/2907383>

VIP-2/PT/FLK14/PLC - Passive module

2903801

<https://www.phoenixcontact.com/us/products/2903801>



VARIOFACE interface module, with push-in connection for 8 channels

PLC-V8/FLK14/OUT - System connection

2295554

<https://www.phoenixcontact.com/us/products/2295554>



V8 adapter for 8 x PLC-INTERFACE (6.2 mm), controller: PLC system cabling of output cards, connection 1: IDC/FLK pin strip 1x 14-position, connection 2: Plug-in connection (Can be snapped onto 8x PLC-INTERFACE terminals), connection 3: Screw connection 1x 2-position, number of channels: 8, control logic: positive switching

FLKM 50-PA/SC/DIO/S7-1500 - Front adapter



2907383

<https://www.phoenixcontact.com/us/products/2907383>

PLC-V8/FLK14/IN - System connection

2296553

<https://www.phoenixcontact.com/us/products/2296553>



V8 adapter for 8 x PLC-INTERFACE (6.2 mm), controller: PLC system cabling of input cards, connection 1: IDC/FLK pin strip 1x 14-position, connection 2: Plug-in connection (Can be snapped onto 8x PLC-INTERFACE terminals), connection 3: Screw connection 1x 2-position, number of channels: 8, control logic: positive switching

PLC-V8L/FLK14/OUT - System connection

2299660

<https://www.phoenixcontact.com/us/products/2299660>



V8 adapter for 8 x PLC-INTERFACE (14 mm), controller: PLC system cabling of output cards, connection 1: IDC/FLK pin strip 1x 14-position, connection 2: Plug-in connection (Can be snapped onto 8x PLC-INTERFACE terminals), connection 3: Screw connection 1x 2-position, number of channels: 8, control logic: positive switching

FLKM 50-PA/SC/DIO/S7-1500 - Front adapter

2907383

<https://www.phoenixcontact.com/us/products/2907383>



FLKM 50/KDS3-MT/PPA/S7-1500 - Interface module

2909893

<https://www.phoenixcontact.com/us/products/2909893>

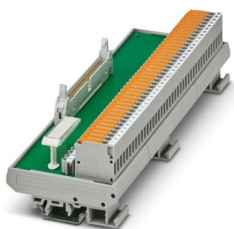

VARIOFACE termination board for Siemens SIMATIC® S7-1500, with SIMATIC®-specific marking (1-40), knife-disconnect terminal block, and test pick-off

FLK 50/EZ-DR/ 50/KONFEK - Cable

2289065

<https://www.phoenixcontact.com/us/products/2289065>

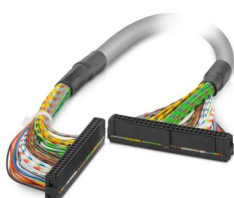

Round cable set; connection 1: IDC/FLK socket strip (1x 50-position); connection 2: IDC/FLK socket strip (1x 50-position); cable length: 0.5 m

FLKM 50-PA/SC/DIO/S7-1500 - Front adapter

2907383

<https://www.phoenixcontact.com/us/products/2907383>

FLK 50/EZ-DR/ 100/KONFEK - Cable

2289078

<https://www.phoenixcontact.com/us/products/2289078>



Round cable set; connection 1: IDC/FLK socket strip (1x 50-position); connection 2: IDC/FLK socket strip (1x 50-position); cable length: 1 m

FLK 50/EZ-DR/ 150/KONFEK - Cable

2289081

<https://www.phoenixcontact.com/us/products/2289081>



Round cable set; connection 1: IDC/FLK socket strip (1x 50-position); connection 2: IDC/FLK socket strip (1x 50-position); cable length: 1.5 m

FLKM 50-PA/SC/DIO/S7-1500 - Front adapter

2907383

<https://www.phoenixcontact.com/us/products/2907383>



FLK 50/EZ-DR/ 200/KONFEK - Cable

2289094

<https://www.phoenixcontact.com/us/products/2289094>



Round cable set; connection 1: IDC/FLK socket strip (1x 50-position); connection 2: IDC/FLK socket strip (1x 50-position); cable length: 2 m

FLK 50/EZ-DR/ 250/KONFEK - Cable

2289104

<https://www.phoenixcontact.com/us/products/2289104>

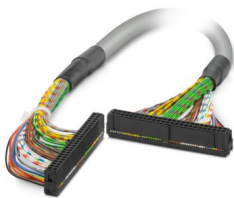

Round cable set; connection 1: IDC/FLK socket strip (1x 50-position); connection 2: IDC/FLK socket strip (1x 50-position); cable length: 2.5 m

FLKM 50-PA/SC/DIO/S7-1500 - Front adapter

2907383

<https://www.phoenixcontact.com/us/products/2907383>



FLK 50/EZ-DR/ 300/KONFEK - Cable

2289117

<https://www.phoenixcontact.com/us/products/2289117>

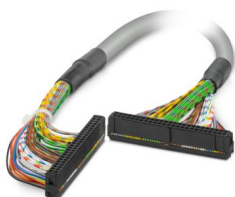

Round cable set; connection 1: IDC/FLK socket strip (1x 50-position); connection 2: IDC/FLK socket strip (1x 50-position); cable length: 3 m

FLK 50/EZ-DR/ 350/KONFEK - Cable

2289120

<https://www.phoenixcontact.com/us/products/2289120>

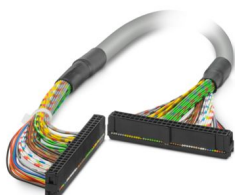

Round cable set; connection 1: IDC/FLK socket strip (1x 50-position); connection 2: IDC/FLK socket strip (1x 50-position); cable length: 3.5 m

FLKM 50-PA/SC/DIO/S7-1500 - Front adapter



2907383

<https://www.phoenixcontact.com/us/products/2907383>

FLK 50/EZ-DR/ 400/KONFEK - Cable

2289133

<https://www.phoenixcontact.com/us/products/2289133>

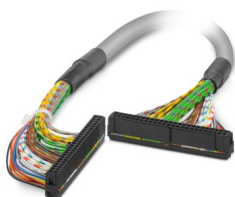

Round cable set; connection 1: IDC/FLK socket strip (1x 50-position); connection 2: IDC/FLK socket strip (1x 50-position); cable length: 4 m

FLK 50/EZ-DR/ 450/KONFEK - Cable

2289573

<https://www.phoenixcontact.com/us/products/2289573>

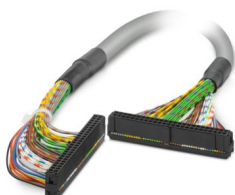

Round cable set; connection 1: IDC/FLK socket strip (1x 50-position); connection 2: IDC/FLK socket strip (1x 50-position); cable length: 4.5 m

FLKM 50-PA/SC/DIO/S7-1500 - Front adapter



2907383

<https://www.phoenixcontact.com/us/products/2907383>

FLK 50/EZ-DR/ 500/KONFEK - Cable

2289586

<https://www.phoenixcontact.com/us/products/2289586>

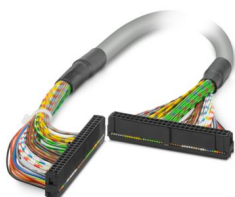

Round cable set; connection 1: IDC/FLK socket strip (1x 50-position); connection 2: IDC/FLK socket strip (1x 50-position); cable length: 5 m

FLK 50/EZ-DR/ 550/KONFEK - Cable

2289599

<https://www.phoenixcontact.com/us/products/2289599>

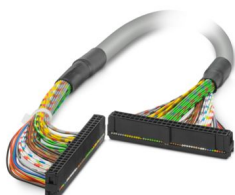

Round cable set; connection 1: IDC/FLK socket strip (1x 50-position); connection 2: IDC/FLK socket strip (1x 50-position); cable length: 5.5 m

FLKM 50-PA/SC/DIO/S7-1500 - Front adapter



2907383

<https://www.phoenixcontact.com/us/products/2907383>

FLK 50/EZ-DR/ 600/KONFEK - Cable

2289609

<https://www.phoenixcontact.com/us/products/2289609>

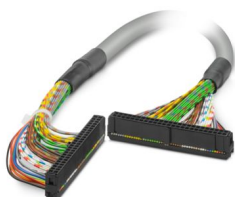

Round cable set; connection 1: IDC/FLK socket strip (1x 50-position); connection 2: IDC/FLK socket strip (1x 50-position); cable length: 6 m

FLK 50/EZ-DR/ 700/KONFEK - Cable

2289625

<https://www.phoenixcontact.com/us/products/2289625>

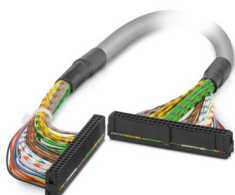

Round cable set; connection 1: IDC/FLK socket strip (1x 50-position); connection 2: IDC/FLK socket strip (1x 50-position); cable length: 7 m

FLKM 50-PA/SC/DIO/S7-1500 - Front adapter

2907383

<https://www.phoenixcontact.com/us/products/2907383>



FLK 50/EZ-DR/ 750/KONFEK - Cable

2289638

<https://www.phoenixcontact.com/us/products/2289638>

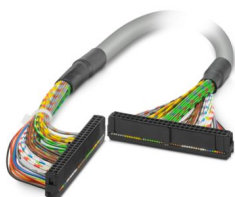

Round cable set; connection 1: IDC/FLK socket strip (1x 50-position); connection 2: IDC/FLK socket strip (1x 50-position); cable length: 7.5 m

FLK 50/EZ-DR/ 800/KONFEK - Cable

2289641

<https://www.phoenixcontact.com/us/products/2289641>

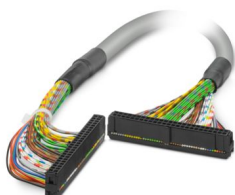

Round cable set; connection 1: IDC/FLK socket strip (1x 50-position); connection 2: IDC/FLK socket strip (1x 50-position); cable length: 8 m

FLKM 50-PA/SC/DIO/S7-1500 - Front adapter



2907383

<https://www.phoenixcontact.com/us/products/2907383>

FLK 50/EZ-DR/ 850/KONFEK - Cable

2289654

<https://www.phoenixcontact.com/us/products/2289654>

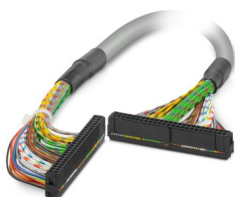

Round cable set; connection 1: IDC/FLK socket strip (1x 50-position); connection 2: IDC/FLK socket strip (1x 50-position); cable length: 8.5 m

FLK 50/EZ-DR/ 900/KONFEK - Cable

2289667

<https://www.phoenixcontact.com/us/products/2289667>

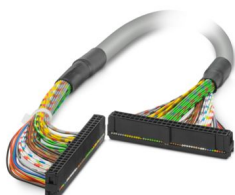

Round cable set; connection 1: IDC/FLK socket strip (1x 50-position); connection 2: IDC/FLK socket strip (1x 50-position); cable length: 9 m

FLKM 50-PA/SC/DIO/S7-1500 - Front adapter

2907383

<https://www.phoenixcontact.com/us/products/2907383>



FLK 50/EZ-DR/1000/KONFEK - Cable

2289683

<https://www.phoenixcontact.com/us/products/2289683>



Round cable set; connection 1: IDC/FLK socket strip (1x 50-position); connection 2: IDC/FLK socket strip (1x 50-position); cable length: 10 m

FLK 50/EZ-DR/ 125/KONFEK - Cable

2296197

<https://www.phoenixcontact.com/us/products/2296197>

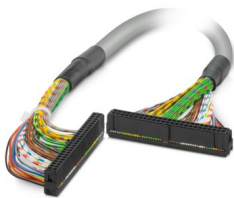

Round cable set; connection 1: IDC/FLK socket strip (1x 50-position); connection 2: IDC/FLK socket strip (1x 50-position); cable length: 1.25 m

FLKM 50-PA/SC/DIO/S7-1500 - Front adapter

2907383

<https://www.phoenixcontact.com/us/products/2907383>



FLK 50/EZ-DR/1200/KONFEK - Cable

2296223

<https://www.phoenixcontact.com/us/products/2296223>

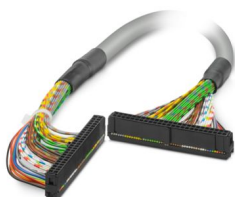

Round cable set; connection 1: IDC/FLK socket strip (1x 50-position); connection 2: IDC/FLK socket strip (1x 50-position); cable length: 12 m

FLK 50/EZ-DR/ 50/KONFEK/S - Cable

2299097

<https://www.phoenixcontact.com/us/products/2299097>



Assembled shielded round cable; connection 1: IDC/FLK socket strip (1x 50-position); connection 2: IDC/FLK socket strip (1x 50-position) (The braided shield is routed to a separate cable end.); cable length: 0.5 m

FLKM 50-PA/SC/DIO/S7-1500 - Front adapter



2907383

<https://www.phoenixcontact.com/us/products/2907383>

FLK 50/EZ-DR/ 100/KONFEK/S - Cable

2299107

<https://www.phoenixcontact.com/us/products/2299107>



Assembled shielded round cable; connection 1: IDC/FLK socket strip (1x 50-position); connection 2: IDC/FLK socket strip (1x 50-position) (The braided shield is routed to a separate cable end.); cable length: 1 m

FLK 50/EZ-DR/ 150/KONFEK/S - Cable

2299110

<https://www.phoenixcontact.com/us/products/2299110>



Assembled shielded round cable; connection 1: IDC/FLK socket strip (1x 50-position); connection 2: IDC/FLK socket strip (1x 50-position) (The braided shield is routed to a separate cable end.); cable length: 1.5 m

FLKM 50-PA/SC/DIO/S7-1500 - Front adapter

2907383

<https://www.phoenixcontact.com/us/products/2907383>



FLK 50/EZ-DR/ 200/KONFEK/S - Cable

2299123

<https://www.phoenixcontact.com/us/products/2299123>



Assembled shielded round cable; connection 1: IDC/FLK socket strip (1x 50-position); connection 2: IDC/FLK socket strip (1x 50-position) (The braided shield is routed to a separate cable end.); cable length: 2 m

FLK 50/EZ-DR/ 300/KONFEK/S - Cable

2299136

<https://www.phoenixcontact.com/us/products/2299136>



Assembled shielded round cable; connection 1: IDC/FLK socket strip (1x 50-position); connection 2: IDC/FLK socket strip (1x 50-position) (The braided shield is routed to a separate cable end.); cable length: 3 m

FLKM 50-PA/SC/DIO/S7-1500 - Front adapter



2907383

<https://www.phoenixcontact.com/us/products/2907383>

FLK 50/EZ-DR/ 400/KONFEK/S - Cable

2299149

<https://www.phoenixcontact.com/us/products/2299149>



Assembled shielded round cable; connection 1: IDC/FLK socket strip (1x 50-position); connection 2: IDC/FLK socket strip (1x 50-position) (The braided shield is routed to a separate cable end.); cable length: 4 m

FLK 50/EZ-DR/ 600/KONFEK/S - Cable

2299152

<https://www.phoenixcontact.com/us/products/2299152>



Assembled shielded round cable; connection 1: IDC/FLK socket strip (1x 50-position); connection 2: IDC/FLK socket strip (1x 50-position) (The braided shield is routed to a separate cable end.); cable length: 6 m

FLKM 50-PA/SC/DIO/S7-1500 - Front adapter



2907383

<https://www.phoenixcontact.com/us/products/2907383>

FLK 50/EZ-DR/1000/KONFEK/S - Cable

2299178

<https://www.phoenixcontact.com/us/products/2299178>



Assembled shielded round cable; connection 1: IDC/FLK socket strip (1x 50-position); connection 2: IDC/FLK socket strip (1x 50-position) (The braided shield is routed to a separate cable end.); cable length: 10 m

CABLE-FLK50/0,14/HF/ 0,5M - Cable

2314134

<https://www.phoenixcontact.com/us/products/2314134>



Assembled, halogen-free round cable; connection 1: IDC/FLK socket strip (1x 50-position); connection 2: IDC/FLK socket strip (1x 50-position); cable length: 0.5 m

FLKM 50-PA/SC/DIO/S7-1500 - Front adapter



2907383

<https://www.phoenixcontact.com/us/products/2907383>

CABLE-FLK50/0,14/HF/ 1,0M - Cable

2314147

<https://www.phoenixcontact.com/us/products/2314147>

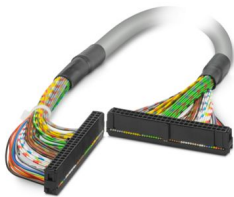

Assembled, halogen-free round cable; connection 1: IDC/FLK socket strip (1x 50-position); connection 2: IDC/FLK socket strip (1x 50-position); cable length: 1 m

CABLE-FLK50/0,14/HF/ 1,5M - Cable

2314150

<https://www.phoenixcontact.com/us/products/2314150>



Assembled, halogen-free round cable; connection 1: IDC/FLK socket strip (1x 50-position); connection 2: IDC/FLK socket strip (1x 50-position); cable length: 1.5 m

FLKM 50-PA/SC/DIO/S7-1500 - Front adapter

2907383

<https://www.phoenixcontact.com/us/products/2907383>

CABLE-FLK50/0,14/HF/ 2,0M - Cable

2314163

<https://www.phoenixcontact.com/us/products/2314163>

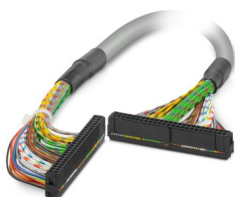

Assembled, halogen-free round cable; connection 1: IDC/FLK socket strip (1x 50-position); connection 2: IDC/FLK socket strip (1x 50-position); cable length: 2 m

CABLE-FLK50/0,14/HF/ 2,5M - Cable

2314176

<https://www.phoenixcontact.com/us/products/2314176>

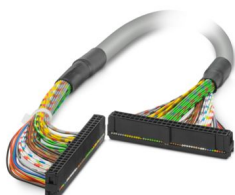

Assembled, halogen-free round cable; connection 1: IDC/FLK socket strip (1x 50-position); connection 2: IDC/FLK socket strip (1x 50-position); cable length: 2.5 m

FLKM 50-PA/SC/DIO/S7-1500 - Front adapter



2907383

<https://www.phoenixcontact.com/us/products/2907383>

CABLE-FLK50/0,14/HF/ 3,0M - Cable

2314189

<https://www.phoenixcontact.com/us/products/2314189>



Assembled, halogen-free round cable; connection 1: IDC/FLK socket strip (1x 50-position); connection 2: IDC/FLK socket strip (1x 50-position); cable length: 3 m

CABLE-FLK50/0,14/HF/ 4,0M - Cable

2314192

<https://www.phoenixcontact.com/us/products/2314192>

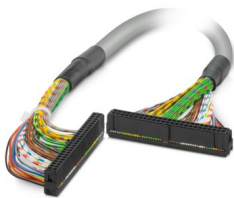

Assembled, halogen-free round cable; connection 1: IDC/FLK socket strip (1x 50-position); connection 2: IDC/FLK socket strip (1x 50-position); cable length: 4 m

FLKM 50-PA/SC/DIO/S7-1500 - Front adapter



2907383

<https://www.phoenixcontact.com/us/products/2907383>

CABLE-FLK50/0,14/HF/ 5,0M - Cable

2314202

<https://www.phoenixcontact.com/us/products/2314202>

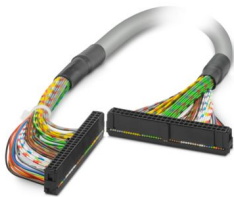

Assembled, halogen-free round cable; connection 1: IDC/FLK socket strip (1x 50-position); connection 2: IDC/FLK socket strip (1x 50-position); cable length: 5 m

CABLE-FLK50/0,14/HF/10,0M - Cable

2314244

<https://www.phoenixcontact.com/us/products/2314244>



Assembled, halogen-free round cable; connection 1: IDC/FLK socket strip (1x 50-position); connection 2: IDC/FLK socket strip (1x 50-position); cable length: 10 m

FLKM 50-PA/SC/DIO/S7-1500 - Front adapter

2907383

<https://www.phoenixcontact.com/us/products/2907383>

CABLE-FLK50-0,14-HF/... - Cable

2314257

<https://www.phoenixcontact.com/us/products/2314257>

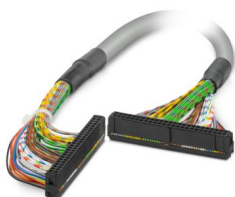

Assembled, halogen-free round cable; connection 1: IDC/FLK socket strip (1x 50-position); connection 2: IDC/FLK socket strip (1x 50-position); cable length: variable

FLK 50/4X14/EZ-DR/ 50/KONFEK - Cable

2296689

<https://www.phoenixcontact.com/us/products/2296689>



Round cable set; connection 1: IDC/FLK socket strip (1x 50-position); connection 2: IDC/FLK socket strip (4x 14-position); cable length: 0.5 m

FLKM 50-PA/SC/DIO/S7-1500 - Front adapter



2907383

<https://www.phoenixcontact.com/us/products/2907383>

FLK 50/4X14/EZ-DR/ 100/KONFEK - Cable

2296692

<https://www.phoenixcontact.com/us/products/2296692>



Round cable set; connection 1: IDC/FLK socket strip (1x 50-position); connection 2: IDC/FLK socket strip (4x 14-position); cable length: 1 m

FLK 50/4X14/EZ-DR/ 150/KONFEK - Cable

2296702

<https://www.phoenixcontact.com/us/products/2296702>



Round cable set; connection 1: IDC/FLK socket strip (1x 50-position); connection 2: IDC/FLK socket strip (4x 14-position); cable length: 1.5 m

FLKM 50-PA/SC/DIO/S7-1500 - Front adapter

2907383

<https://www.phoenixcontact.com/us/products/2907383>



FLK 50/4X14/EZ-DR/ 200/KONFEK - Cable

2296715

<https://www.phoenixcontact.com/us/products/2296715>



Round cable set; connection 1: IDC/FLK socket strip (1x 50-position); connection 2: IDC/FLK socket strip (4x 14-position); cable length: 2 m

FLK 50/4X14/EZ-DR/ 250/KONFEK - Cable

2305402

<https://www.phoenixcontact.com/us/products/2305402>



Round cable set; connection 1: IDC/FLK socket strip (1x 50-position); connection 2: IDC/FLK socket strip (4x 14-position); cable length: 2.5 m

FLKM 50-PA/SC/DIO/S7-1500 - Front adapter

2907383

<https://www.phoenixcontact.com/us/products/2907383>

FLK 50/4X14/EZ-DR/ 300/KONFEK - Cable

2296728

<https://www.phoenixcontact.com/us/products/2296728>



Round cable set; connection 1: IDC/FLK socket strip (1x 50-position); connection 2: IDC/FLK socket strip (4x 14-position); cable length: 3 m

FLK 50/4X14/EZ-DR/ 400/KONFEK - Cable

2296731

<https://www.phoenixcontact.com/us/products/2296731>



Round cable set; connection 1: IDC/FLK socket strip (1x 50-position); connection 2: IDC/FLK socket strip (4x 14-position); cable length: 4 m

FLKM 50-PA/SC/DIO/S7-1500 - Front adapter

2907383

<https://www.phoenixcontact.com/us/products/2907383>



FLK 50/4X14/EZ-DR/ 600/KONFEK - Cable

2296744

<https://www.phoenixcontact.com/us/products/2296744>



Round cable set; connection 1: IDC/FLK socket strip (1x 50-position); connection 2: IDC/FLK socket strip (4x 14-position); cable length: 6 m

FLK 50/4X14/EZ-DR/1000/KONFEK - Cable

2296773

<https://www.phoenixcontact.com/us/products/2296773>



Round cable set; connection 1: IDC/FLK socket strip (1x 50-position); connection 2: IDC/FLK socket strip (4x 14-position); cable length: 10 m

FLKM 50-PA/SC/DIO/S7-1500 - Front adapter

2907383

<https://www.phoenixcontact.com/us/products/2907383>



FLK 50-4X14-EZ-DR ... - Cable

2302405

<https://www.phoenixcontact.com/us/products/2302405>



Round cable set; connection 1: IDC/FLK socket strip (1x 50-position); connection 2: IDC/FLK socket strip (4x 14-position); cable length: variable

FLK 50-4X14-EZ-DR-S ... - Cable

2302447

<https://www.phoenixcontact.com/us/products/2302447>



Assembled shielded round cable; connection 1: IDC/FLK socket strip (1x 50-position); connection 2: IDC/FLK socket strip (4x 14-position) (The braided shield is routed to four separate cable ends.); cable length: variable

Phoenix Contact 2024 © - all rights reserved
<https://www.phoenixcontact.com>

Phoenix Contact USA
586 Fulling Mill Road
Middletown, PA 17057, United States
(+717) 944-1300
info@phoenixcon.com