

# MINI MCR-2-RPSS-I-2I-PT - Repeater power supply



2905629

<https://www.phoenixcontact.com/us/products/2905629>

Please be informed that the data shown in this PDF document is generated from our online catalog. Please find the complete data in the user documentation. Our general terms of use for downloads are valid.

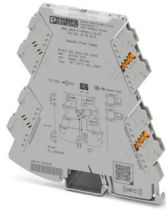

4-way power supply doubler with plug-in connection technology. HART-transparent, 0(4) mA ... 20 mA input signal, 0(4) mA ... 20 mA output signals. The device can be used in both signal and power supply doubler modes. Push-in connection technology.

## Product description

The power supply duplicator with plug-in connection technology supplies the transmitter in the field and electrically isolates the input signal transmitted to two loads. HART data protocols can be transmitted bi-directionally via both outputs. You can use the device in signal and power supply duplicator mode with a transmitter supply voltage of  $>19.5$  V. On the output side, the module can be connected to passive input cards. For a maximum load of  $\leq 500$   $\Omega$  per channel, electrically isolated analog standard signals 0 mA ... 20 mA or 4 mA ... 20 mA are available. The measuring transducer supports fault monitoring and NFC communication.

## Commercial data

Item number	2905629
Packing unit	1 pc
Minimum order quantity	1 pc
Sales key	C404
Product key	CK1411
Catalog page	Page 78 (C-5-2019)
GTIN	4046356999441
Weight per piece (including packing)	120.6 g
Weight per piece (excluding packing)	120 g
Customs tariff number	85437090
Country of origin	DE

# MINI MCR-2-RPSS-I-2I-PT - Repeater power supply



2905629

<https://www.phoenixcontact.com/us/products/2905629>

## Technical data

### Notes

#### Utilization restriction

EMC note	EMC: class A product, see manufacturer's declaration in the download area
----------	---

### Product properties

Product type	Repeater power supplies
Product family	MINI Analog Pro
No. of channels	2
Type	Signal conditioner
Configuration	DIP switches

#### Insulation characteristics: GB Standard

Overvoltage category	II
Pollution degree	2

### Electrical properties

Electrical isolation	4-way isolation
Limit frequency (3 dB)	> 1 kHz
Signal transmission behavior	In = Out
Step response (10-90%)	< 400 $\mu$ s
Maximum temperature coefficient	0.0075 %/K
Maximum transmission error	0.05 % (of final value)

#### Electrical isolation Input/output/power supply

Rated insulation voltage	300 V <sub>rms</sub>
Test voltage	3 kV AC (50 Hz, 60 s)
Insulation	Reinforced insulation according to IEC/EN 61010-1

#### Supply

Nominal supply voltage	24 V DC
Supply voltage range	9.6 V DC ... 30 V DC (The DIN rail connector (ME 6,2 TBUS-2 1,5/5-ST-3,81 GN, item no. 2869728) can be used to bridge the supply voltage. It can be snapped onto a 35 mm DIN rail in accordance with EN 60715)
Typical current consumption	40 mA (For 24 V DC and in signal duplicator mode)
	65 mA (For 24 V DC and in power supply duplicator mode)
	75 mA (For 12 V DC and in signal duplicator mode)
	130 mA (For 12 V DC and in power supply duplicator mode)
Power consumption	1.6 W (at I <sub>OUT</sub> = 20 mA, 500 $\Omega$ load)

### Input data

Signal: Current

# MINI MCR-2-RPSS-I-2I-PT - Repeater power supply



2905629

<https://www.phoenixcontact.com/us/products/2905629>

Description of the input	Sensor circuit
Number of inputs	1
Current input signal	0 mA ... 20 mA (Signal duplicator mode)
	4 mA ... 20 mA (Power supply and signal duplicator mode)
Input resistance current input	90 Ω (+1.6 V)
Transmitter supply voltage	> 19.5 V

## Output data

Signal: Current

Number of outputs	2
Non-load voltage	< 20 V
Current output signal	0 mA ... 20 mA (Signal duplicator mode)
	4 mA ... 20 mA (Power supply and signal duplicator mode)
Max. current output signal	25 mA
Load/output load current output	≤ 500 Ω (per channel)
Ripple	< 20 mV <sub>PP</sub> (500 Ω)

## Connection data

Connection method	Push-in connection
Stripping length	10 mm
Conductor cross section rigid	0.2 mm <sup>2</sup> ... 2.5 mm <sup>2</sup> (with ferrule)
	0.14 mm <sup>2</sup> ... 2.5 mm <sup>2</sup> (without ferrule)
Conductor cross section flexible	0.14 mm <sup>2</sup> ... 2.5 mm <sup>2</sup>
Conductor cross section AWG	24 ... 12 (flexible)

## Ex data

Ex installation (EPL)	Gc
	Div. 2

## Interfaces

Data communication (bypass)

HART function	Yes
Limit frequency (3 dB)	≈  kHz

## Signaling

Status display	Green LED (supply voltage)
----------------	----------------------------

## Dimensions

Width	6.2 mm
Height	109.81 mm
Depth	119.2 mm

## Material specifications

Color	gray (RAL 7042)
-------	-----------------

# MINI MCR-2-RPSS-I-2I-PT - Repeater power supply



2905629

<https://www.phoenixcontact.com/us/products/2905629>

Housing material	PBT
Fire protection for rail vehicles (DIN EN 45545-2) R22	HL 1 - HL 2
Fire protection for rail vehicles (DIN EN 45545-2) R23	HL 1 - HL 2
Fire protection for rail vehicles (DIN EN 45545-2) R24	HL 1 - HL 2

## Environmental and real-life conditions

### Ambient conditions

Degree of protection	IP20 (not assessed by UL)
Ambient temperature (operation)	-40 °C ... 70 °C
Ambient temperature (storage/transport)	-40 °C ... 85 °C
Altitude	≤ 2000 m
Permissible humidity (operation)	5 % ... 95 % (non-condensing)

## Approvals

### CE

Certificate	CE-compliant
-------------	--------------

### ATEX

Identification	⊕ II 3 G Ex ec ic IIC T4 Gc
Certificate	BVS 19 ATEX E 047 X

### UKCA Ex (UKEX)

Identification	⊕ II 3 G Ex ec ic IIC T4 Gc
Certificate	PxCIF21UKEX2902000X

### IECEX

Identification	Ex ec ic IIC T4 Gc
Certificate	IECEX BVS 19.0041X

### CCC / China-Ex

Identification	Ex nA ic IIC T4 Gc
----------------	--------------------

### UL, USA/Canada

Identification	UL 508 Listed
	Class I, Div. 2, Groups A, B, C, D T5
	Class I, Zone 2, Group IIC T5

### Shipbuilding approval

Certificate	DNV GL TAA000021E Rev. 1
-------------	--------------------------

### EAC Ex

Identification	⊕ Ex ec ic IIC T4 Gc
Certificate	BY/112 02.01 TP012 103.01 00081

### DNV GL data

Temperature	B
Humidity	B

# MINI MCR-2-RPSS-I-2I-PT - Repeater power supply



2905629

<https://www.phoenixcontact.com/us/products/2905629>

Vibration	A
EMC	A
Enclosure	Required protection according to the Rules shall be provided upon installation on board

## EMC data

Noise immunity	EN 61000-6-2
Note	When being exposed to interference, there may be minimal deviations.
Electromagnetic compatibility	Conformance with EMC directive
Noise emission	EN 61000-6-4

### Electrostatic discharge

Standards/regulations	EN 61000-4-2
-----------------------	--------------

### Electrostatic discharge

Comments	Safety measures must be taken to prevent electrostatic discharge.
----------	---

### Electromagnetic HF field

Designation	Electromagnetic RF field
Standards/regulations	EN 61000-4-3

### Fast transients (burst)

Designation	Fast transients (burst)
Standards/regulations	EN 61000-4-4

### Surge current load (surge)

Standards/regulations	EN 61000-4-5
-----------------------	--------------

### Conducted interference

Designation	Conducted interferences
Standards/regulations	EN 61000-4-6

## Standards and regulations

Electrical isolation	4-way isolation
----------------------	-----------------

### GB Standard

Standards/regulations	GB 3836.1
	GB 3836.4
	GB 3836.8

## Mounting

Mounting type	DIN rail mounting
Assembly note	The DIN rail connector can be used for bridging the supply voltage. It can be snapped onto a 35 mm EN 60715 DIN rail.
Mounting position	any

# MINI MCR-2-RPSS-I-2I-PT - Repeater power supply

2905629

<https://www.phoenixcontact.com/us/products/2905629>

## Drawings

Block diagram

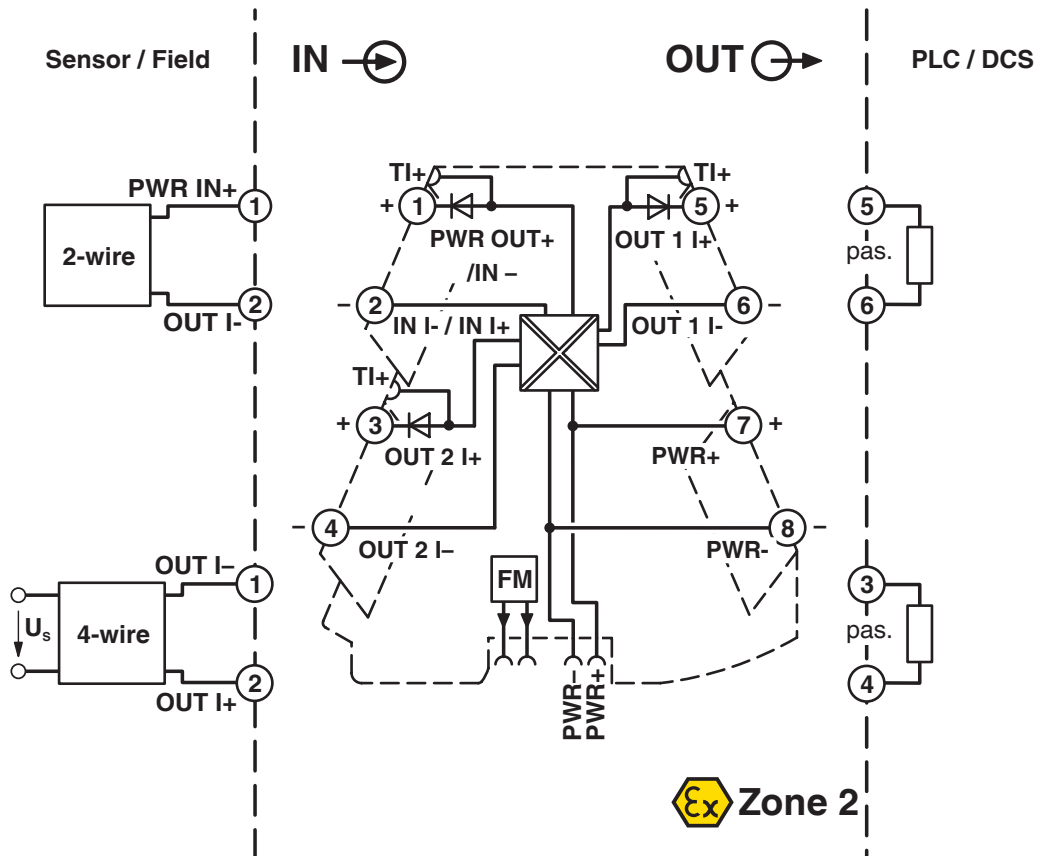

# MINI MCR-2-RPSS-I-2I-PT - Repeater power supply



2905629

<https://www.phoenixcontact.com/us/products/2905629>

## Approvals

To download certificates, visit the product detail page: <https://www.phoenixcontact.com/us/products/2905629>



**EAC**

Approval ID: RU\*DE.\*08.B.01608/19



**UL Listed**

Approval ID: FILE E 238705



**CCC**

Approval ID: 2021322303003858



**cUL Listed**

Approval ID: FILE E 238705

**DNV**

Approval ID: TAA000021E



**IECEX**

Approval ID: IECEX BVS 19.0041X



**cUL Listed**

Approval ID: FILE E 196811



**UL Listed**

Approval ID: FILE E 196811



**ATEX**

Approval ID: BVS 19 ATEX E 047 X

**cULus Listed**

**cULus Listed**

# MINI MCR-2-RPSS-I-2I-PT - Repeater power supply



2905629

<https://www.phoenixcontact.com/us/products/2905629>

## Classifications

### ECLASS

ECLASS-11.0	27210120
ECLASS-12.0	27210120
ECLASS-13.0	27210120

### ETIM

ETIM 9.0	EC002653
----------	----------

### UNSPSC

UNSPSC 21.0	39121000
-------------	----------



2905629

<https://www.phoenixcontact.com/us/products/2905629>

## Environmental product compliance

### EU RoHS

Fulfills EU RoHS substance requirements	Yes
Exemption	7(a), 7(c)-I

### China RoHS

Environment friendly use period (EFUP)	EFUP-50
	An article-related China RoHS declaration table can be found in the download area for the respective article under "Manufacturer declaration". For all articles with EFUP-E, no China RoHS declaration table issued and required.

### EU REACH SVHC

REACH candidate substance (CAS No.)	Lead(CAS: 7439-92-1)
SCIP	1c9fe81b-c157-461c-9280-e6e1bbb0718c

### EF3.0 Climate Change

CO2e kg	5.852 kg CO2e
---------	---------------

# MINI MCR-2-RPSS-I-2I-PT - Repeater power supply



2905629

<https://www.phoenixcontact.com/us/products/2905629>

## Accessories

### ME 6,2 TBUS-2 1,5/5-ST-3,81 GY - DIN rail bus connectors

2695439

<https://www.phoenixcontact.com/us/products/2695439>

DIN rail connector (TBUS), 5-pos., for bridging the supply voltage, can be snapped onto NS 35/... DIN rail in accordance with EN 60715



---

### ME 6,2 TBUS-2 1,5/5-ST-3,81 GN - DIN rail bus connectors

2869728

<https://www.phoenixcontact.com/us/products/2869728>

DIN rail connector for DIN rail mounting. Universal for TBUS housing. Gold-plated contacts, 5-pos.

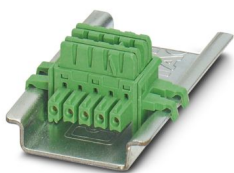

# MINI MCR-2-RPSS-I-2I-PT - Repeater power supply

2905629

<https://www.phoenixcontact.com/us/products/2905629>



## GW HART USB MODEM - Cable adapter

1003824

<https://www.phoenixcontact.com/us/products/1003824>



USB HART modem cable for communication between a PC and HART devices, cable length: 1 m.

---

## TC-D37SUB-AIO16-MP-PS-UNI - Module carrier

2906640

<https://www.phoenixcontact.com/us/products/2906640>

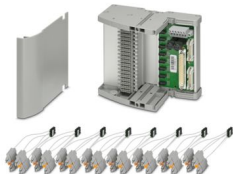

Universal Termination Carrier for connecting 16 MINI Analog Pro signal conditioners to digital or analog I/O cards, via D-SUB connector, 37-pos. (1:1 connection), with HART multiplexer connection

# MINI MCR-2-RPSS-I-2I-PT - Repeater power supply

2905629

<https://www.phoenixcontact.com/us/products/2905629>



## TC-D37SUB-ADIO16-MP-P-UNI - Module carrier

2906639

<https://www.phoenixcontact.com/us/products/2906639>

Universal Termination Carrier for connecting 16 MINI Analog Pro signal conditioners to digital or analog I/O cards, via D-SUB connector, 37-pos. (1:1 connection)



---

## MINI MCR-2-V8-FLK 16 - System adapter

2901993

<https://www.phoenixcontact.com/us/products/2901993>

Eight MINI Analog Pro signal conditioners and measuring transducers can be connected to a controller with minimal cabling effort and without any errors using system adapters and system cabling.



# MINI MCR-2-RPSS-I-2I-PT - Repeater power supply



2905629

<https://www.phoenixcontact.com/us/products/2905629>

## MINI MCR-2-V8-MOD-RTU - Communication module

2905634

<https://www.phoenixcontact.com/us/products/2905634>

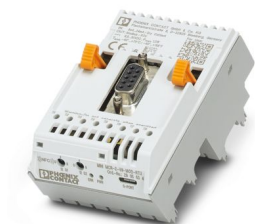

Eight MINI Analog Pro signal conditioners and measuring transducers are quickly and easily integrated into a Modbus/RTU network via a communication adapter.

---

## MINI MCR-2-V8-MOD-TCP - Communication module

2905635

<https://www.phoenixcontact.com/us/products/2905635>



Eight MINI Analog Pro signal conditioners and measuring transducers are quickly and easily integrated into a Modbus/TCP network via a communication adapter.

# MINI MCR-2-RPSS-I-2I-PT - Repeater power supply



2905629

<https://www.phoenixcontact.com/us/products/2905629>

## MINI MCR-2-V8-PB-DP - Communication module

2905636

<https://www.phoenixcontact.com/us/products/2905636>



Eight MINI Analog Pro signal conditioners and measuring transducers are quickly and easily integrated into a PROFIBUS DP network via a communication adapter.

---

## MINI MCR-2-V8-PN - Communication module

2905637

<https://www.phoenixcontact.com/us/products/2905637>



Eight MINI Analog Pro signal conditioners and measuring transducers can be quickly and easily integrated into a PROFINET network via a communication adapter.

# MINI MCR-2-RPSS-I-2I-PT - Repeater power supply



2905629

<https://www.phoenixcontact.com/us/products/2905629>

## FASTCON PRO-SET - Connector set

2906227

<https://www.phoenixcontact.com/us/products/2906227>



FASTCON Pro plug set consisting of four plugs with screw connection, one for each position on the module. Suitable for all MINI Analog Pro modules.

---

## FASTCON PRO-SET-PT - Connector set

2906228

<https://www.phoenixcontact.com/us/products/2906228>



FASTCON Pro plug set consisting of four plugs with push-in connection, one for each position on the module. Suitable for all MINI Analog Pro modules.

# MINI MCR-2-RPSS-I-2I-PT - Repeater power supply



2905629

<https://www.phoenixcontact.com/us/products/2905629>

## UCT-EM (30X5) - Marker for end clamp

0801505

<https://www.phoenixcontact.com/us/products/0801505>



Marker for end clamp, Sheet, white, unlabeled, can be labeled with: TOPMARK NEO, TOPMARK LASER, BLUEMARK ID COLOR, BLUEMARK ID, BLUEMARK CLED, THERMOMARK PRIME, THERMOMARK CARD 2.0, THERMOMARK CARD, mounting type: snapped, lettering field size: 30 x 5 mm, Number of individual labels: 24

---

## UCT-EM (30X5) CUS - Marker for end clamp

0801589

<https://www.phoenixcontact.com/us/products/0801589>



Marker for end clamp, can be ordered: by sheet, white, labeled according to customer specifications, mounting type: snapped into marker carrier, lettering field size: 30 x 5 mm, Number of individual labels: 24



# MINI MCR-2-RPSS-I-2I-PT - Repeater power supply



2905629

<https://www.phoenixcontact.com/us/products/2905629>

## SK 5,0 WH:REEL - Marker strip

0805221

<https://www.phoenixcontact.com/us/products/0805221>



Marker strip, Roll, white, unlabeled, can be labeled with: THERMOMARK E.300 (D)/600 (D), THERMOMARK ROLL 2.0, THERMOMARK ROLL, THERMOMARK ROLL X1, THERMOMARK ROLLMASTER 300/600, THERMOMARK X1.2, mounting type: adhesive, lettering field size: continuous x 5 mm, Number of individual labels: 10

---

## UC-EMLP (15X5) - Plastic label

0819301

<https://www.phoenixcontact.com/us/products/0819301>



Plastic label, Sheet, white, unlabeled, can be labeled with: BLUEMARK ID COLOR, BLUEMARK ID, BLUEMARK CLED, PLOTMARK, CMS-P1-PLOTTER, mounting type: adhesive, lettering field size: 15 x 5 mm, Number of individual labels: 10

# MINI MCR-2-RPSS-I-2I-PT - Repeater power supply



2905629

<https://www.phoenixcontact.com/us/products/2905629>

## UC-EMLP (15X5) YE - Plastic label

0822615

<https://www.phoenixcontact.com/us/products/0822615>

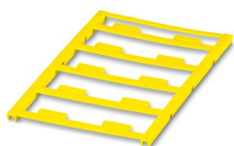

Plastic label, Sheet, yellow, unlabeled, can be labeled with: BLUEMARK ID COLOR, BLUEMARK ID, BLUEMARK CLED, PLOTMARK, CMS-P1-PLOTTER, mounting type: adhesive, lettering field size: 15 x 5 mm, Number of individual labels: 10

---

## UC-EMLP (15X5) CUS - Plastic label

0824550

<https://www.phoenixcontact.com/us/products/0824550>



Plastic label, can be ordered: by sheet, white, labeled according to customer specifications, mounting type: adhesive, lettering field size: 15 x 5 mm

# MINI MCR-2-RPSS-I-2I-PT - Repeater power supply



2905629

<https://www.phoenixcontact.com/us/products/2905629>

## UC-EMLP (15X5) YE CUS - Plastic label

0824551

<https://www.phoenixcontact.com/us/products/0824551>

Plastic label, can be ordered: by sheet, yellow, labeled according to customer specifications, mounting type: adhesive, lettering field size: 15 x 5 mm

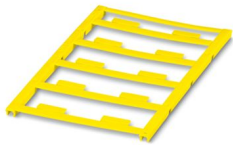

---

## UC-EMLP (15X5) SR - Plastic label

0828095

<https://www.phoenixcontact.com/us/products/0828095>

Plastic label, Sheet, silver, unlabeled, can be labeled with: BLUEMARK ID COLOR, BLUEMARK ID, BLUEMARK CLED, PLOTMARK, CMS-P1-PLOTTER, mounting type: adhesive, lettering field size: 15 x 5 mm, Number of individual labels: 10



# MINI MCR-2-RPSS-I-2I-PT - Repeater power supply



2905629

<https://www.phoenixcontact.com/us/products/2905629>

## UC-EMLP (15X5) SR CUS - Plastic label

0828099

<https://www.phoenixcontact.com/us/products/0828099>



Plastic label, can be ordered: by sheet, silver, labeled according to customer specifications, mounting type: adhesive, lettering field size: 15 x 5 mm, Number of individual labels: 10

---

## US-EMLP (15X5) - Plastic label

0828790

<https://www.phoenixcontact.com/us/products/0828790>



Plastic label, Card, white, unlabeled, can be labeled with: BLUEMARK ID COLOR, BLUEMARK ID, THERMOMARK PRIME, THERMOMARK CARD 2.0, THERMOMARK CARD, mounting type: adhesive, lettering field size: 15 x 5 mm, Number of individual labels: 189

# MINI MCR-2-RPSS-I-2I-PT - Repeater power supply



2905629

<https://www.phoenixcontact.com/us/products/2905629>

## US-EMLP (15X5) YE - Plastic label

0828873

<https://www.phoenixcontact.com/us/products/0828873>



Plastic label, Card, yellow, unlabeled, can be labeled with: BLUEMARK ID COLOR, BLUEMARK ID, THERMOMARK PRIME, THERMOMARK CARD 2.0, THERMOMARK CARD, mounting type: adhesive, lettering field size: 15 x 5 mm, Number of individual labels: 189

---

## US-EMLP (15X5) SR - Plastic label

0828874

<https://www.phoenixcontact.com/us/products/0828874>



Plastic label, Card, silver, unlabeled, can be labeled with: BLUEMARK ID COLOR, BLUEMARK ID, THERMOMARK PRIME, THERMOMARK CARD 2.0, THERMOMARK CARD, mounting type: adhesive, lettering field size: 15 x 5 mm, Number of individual labels: 189

# MINI MCR-2-RPSS-I-2I-PT - Repeater power supply



2905629

<https://www.phoenixcontact.com/us/products/2905629>

## US-EMLP (15X5) CUS - Plastic label

0830076

<https://www.phoenixcontact.com/us/products/0830076>

Plastic label, can be ordered: by card, white, labeled according to customer specifications, mounting type: adhesive, lettering field size: 15 x 5 mm, Number of individual labels: 189



---

## US-EMLP (15X5) YE CUS - Plastic label

0830077

<https://www.phoenixcontact.com/us/products/0830077>

Plastic label, can be ordered: by card, yellow, labeled according to customer specifications, mounting type: adhesive, lettering field size: 15 x 5 mm, Number of individual labels: 189



# MINI MCR-2-RPSS-I-2I-PT - Repeater power supply



2905629

<https://www.phoenixcontact.com/us/products/2905629>

## US-EMLP (15X5) SR CUS - Plastic label

0830078

<https://www.phoenixcontact.com/us/products/0830078>

Plastic label, can be ordered: by card, silver, labeled according to customer specifications, mounting type: adhesive, lettering field size: 15 x 5 mm, Number of individual labels: 189



---

## UCT-EM (30X5) YE - Marker for end clamp

0830340

<https://www.phoenixcontact.com/us/products/0830340>

Marker for end clamp, Sheet, yellow, unlabeled, can be labeled with: TOPMARK NEO, TOPMARK LASER, BLUEMARK ID COLOR, BLUEMARK ID, BLUEMARK CLED, THERMOMARK PRIME, THERMOMARK CARD 2.0, THERMOMARK CARD, mounting type: snapped, lettering field size: 30 x 5 mm, Number of individual labels: 24



# MINI MCR-2-RPSS-I-2I-PT - Repeater power supply

2905629

<https://www.phoenixcontact.com/us/products/2905629>



## UCT-EM (30X5) YE CUS - Marker for end clamp

0830348

<https://www.phoenixcontact.com/us/products/0830348>



Marker for end clamp, can be ordered: by sheet, yellow, labeled according to customer specifications, mounting type: snapped into marker carrier, lettering field size: 30 x 5 mm, Number of individual labels: 24

---

## MINI MCR-2-PTB - Power terminal block

2902066

<https://www.phoenixcontact.com/us/products/2902066>



Power terminal with plug-in connection technology for delivering the supply voltage to the DIN rail connector. Monitoring of the supply voltages in combination with the fault monitoring module. Screw connection technology



# MINI MCR-2-RPSS-I-2I-PT - Repeater power supply

2905629

<https://www.phoenixcontact.com/us/products/2905629>



## MINI MCR-2-PTB-PT - Power terminal block

2902067

<https://www.phoenixcontact.com/us/products/2902067>



Power terminal with plug-in connection technology for delivering the supply voltage to the DIN rail connector. Monitoring of the supply voltages in combination with the fault monitoring module. Push-in connection technology

---

## QUINT4-SYS-PS/1AC/24DC/2.5/SC - Power supply unit

2904614

<https://www.phoenixcontact.com/us/products/2904614>



Primary-switched power supply, QUINT POWER, screw connection, DIN rail mounting, supply of devices possible via the TBUS DIN rail connector, protective coating, input: single-phase, output: 24 V DC/2.5 A

# MINI MCR-2-RPSS-I-2I-PT - Repeater power supply

2905629

<https://www.phoenixcontact.com/us/products/2905629>



## MINI MCR-2-FM-RC - Monitoring block

2904504

<https://www.phoenixcontact.com/us/products/2904504>



Fault monitoring module with plug-in connection technology for evaluating and reporting group errors from the FM system and for monitoring the supply voltages. Error message via N/C contact. Screw connection technology, standard configuration

---

## MINI MCR-2-FM-RC-PT - Monitoring block

2904508

<https://www.phoenixcontact.com/us/products/2904508>



Fault monitoring module with plug-in connection technology for evaluating and reporting group errors from the FM system and for monitoring the supply voltages. Error message via N/C contact. Push-in connection technology, standard configuration

# MINI MCR-2-RPSS-I-2I-PT - Repeater power supply



2905629

<https://www.phoenixcontact.com/us/products/2905629>

## SZS 0,6X3,5 - Screwdriver

1205053

<https://www.phoenixcontact.com/us/products/1205053>



Actuation tool, for ST terminal blocks, insulated, also suitable for use as a bladed screwdriver, size: 0.6 x 3.5 x 100 mm, 2-component grip, with non-slip grip

---

Phoenix Contact 2024 © - all rights reserved

<https://www.phoenixcontact.com>

Phoenix Contact USA  
586 Fulling Mill Road  
Middletown, PA 17057, United States  
(+717) 944-1300  
[info@phoenixcon.com](mailto:info@phoenixcon.com)