



EVBL4572-QB-00A

2A, 60V, High-Efficiency, Synchronous Step-Down Converter Evaluation Board

DESCRIPTION

The EVBL4572-QB-00A is an evaluation board designed to demonstrate the capabilities of the MP4572, a high-efficiency, synchronous step-down converter with integrated internal power MOSFETs (HS-FET and LS-FET, respectively). It can deliver up to 2A of continuous output current, with peak current control for excellent transient response and an MPS power inductor.

The MP4572 features advanced asynchronous mode (AAM) and forced continuous conduction mode (FCCM). AAM helps achieve high efficiency under light-load conditions by scaling back the switching frequency (f_{sw}) to reduce switching and gate driver losses.

The EVBL4572-QB-00A is a fully assembled and tested evaluation board. It generates 5V of output voltage (V_{OUT}) and 2A of continuous output current across a wide 5V to 60V input range.

ELECTRICAL SPECIFICATIONS

Parameter	Symbol	Value	Units
Input voltage	V_{IN}	5 to 60	V
Output voltage	V_{OUT}	5	V
Output current	I_{OUT}	2	A

FEATURES

- Wide 5V to 60V Operating Input Range
- 2A Continuous Output Current
- 40 μ A Quiescent Current
- Up to 2.2MHz Configurable Frequency
- Internal 250m Ω High-Side MOSFET and 45m Ω Low-Side MOSFET
- Low 2 μ A Shutdown Current
- 0.45ms Internal Soft Start (SS)
- 180° Out-of-Phase SYNCOUT Clock
- Synchronous Mode for High-Efficiency Operation
- Selectable Advanced Asynchronous Mode (AAM) or Forced Continuous Conduction Mode (FCCM) for Light-Load Operation
- EN Remote Control
- Power Good (PG) Indicator
- Low-Dropout (LDO) Mode
- Over-Current Protection (OCP)
- Thermal Shutdown (TSD)
- Available in a QFN-12 (2.5mmx3mm) Package

 Optimized Performance with MPS Inductor MPL-AL6060 Series

APPLICATIONS

- Automotive Systems
- Industrial Power Systems

All MPS parts are lead-free, halogen-free, and adhere to the RoHS directive. For MPS green status, please visit the MPS website under Quality Assurance. "MPS", the MPS logo, and "Simple, Easy Solutions" are trademarks of Monolithic Power Systems, Inc. or its subsidiaries.

EVBL4572-QB-00A EVALUATION BOARD



LxWxH (6.35cmx6.35cmx1.3cm)

Board Number	MPS IC Number	MPS Inductor
EVBL4572-QB-00A	MP4572GQB	MPL-AL6060-150

Efficiency vs. Load Current vs. Power Loss

V_{OUT} = 5V, f_{sw} = 450kHz, L = 15μH, AAM

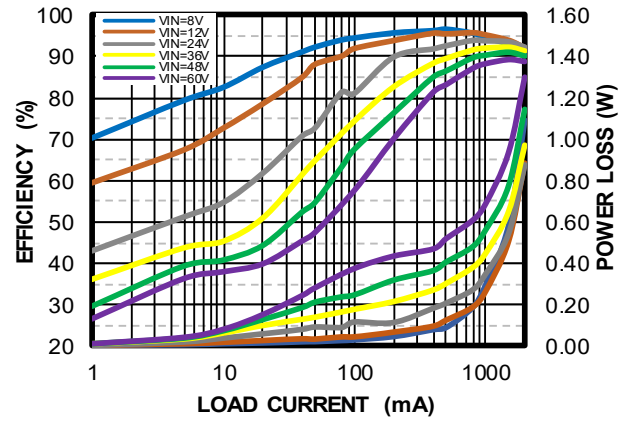

QUICK START GUIDE

1. Preset the power supply between 5V and 60V, then turn off the power supply. ⁽¹⁾
2. If longer cables (>0.5m total) are being used between the source and the evaluation board, install a damping capacitor at the input terminals. This is critical when V_{IN} exceeds 24V.
3. Connect the power supply terminals to:
 - a. Positive (+): V_{IN}
 - b. Negative (-): GND
4. Connect the load terminals to:
 - a. Positive (+): V_{OUT}
 - b. Negative (-): GND
5. After making the connections, turn on the power supply.
6. To use the enable (EN) function, apply a digital input to the EN pin. Drive EN above 1.45V to turn the regulator on; drive EN below 1.12V to turn it off.
7. The oscillating frequency can be configured by the external frequency resistor (R_{FREQ}), which can be estimated with Equation (1):

$$R_{FREQ} (M\Omega) = \frac{30}{f_{sw} (kHz)} \quad (1)$$

8. The output voltage (V_{OUT}) is set by the external resistor dividers ($R4$ and $R5$). The feedback resistor (R_{FB} , $R4$ plus $R6$) also sets the feedback loop bandwidth via the internal compensation capacitor. Select $R4$ to have a value of about 40k Ω . $R5$ can be calculated with Equation (2):

$$R5 = \frac{R4}{\frac{V_{OUT}}{0.8} - 1} \quad (2)$$

Table 1 shows the recommended R_{FB} values for common output voltages.

Table 1: Recommended Resistor Voltages

V_{OUT} (V)	R4 (k Ω)	R5 (k Ω)	R6 (k Ω)
3.3	41.2 (1%)	13 (1%)	20 (1%)
5	41.2 (1%)	7.68 (1%)	20 (1%)
12	41.2 (1%)	2.94 (1%)	20 (1%)

Note:

- 1) Electronic loads represent a negative impedance to the regulator. If the current is too high, hiccup mode is triggered.

EVALUATION BOARD SCHEMATIC

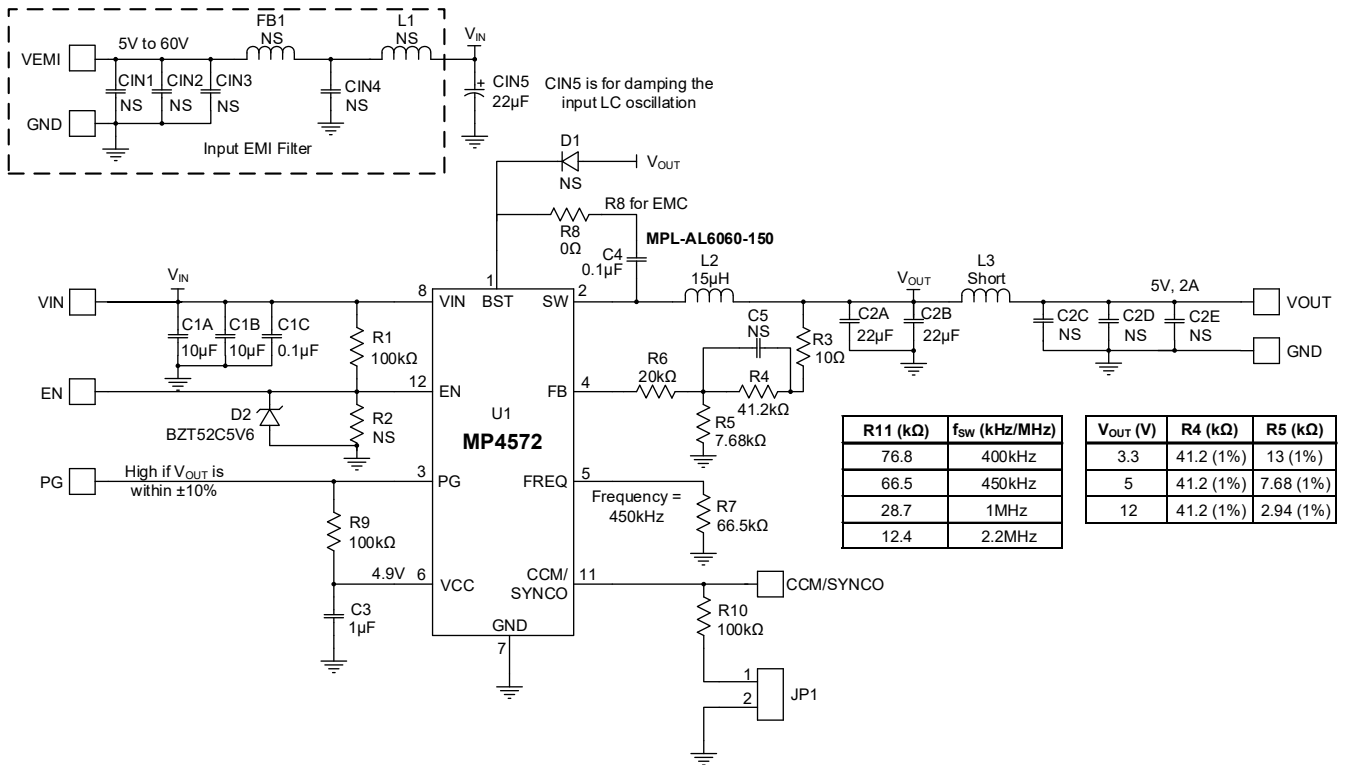
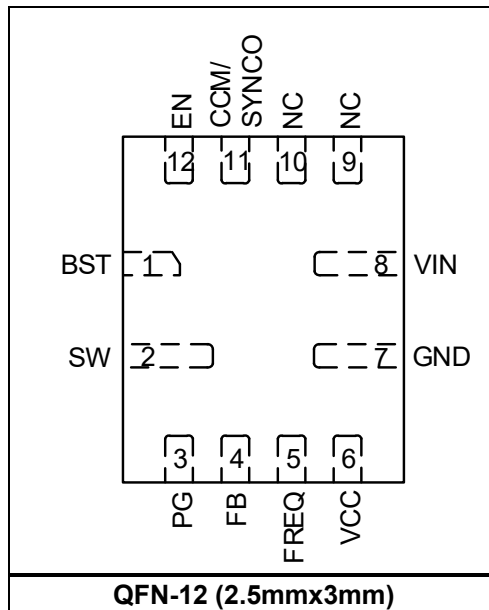

Figure 1: Evaluation Board Schematic

PACKAGE REFERENCE



EVBL4572-QB-00A BILL OF MATERIALS

Qty	Ref	Value	Description	Package	Manufacturer	Manufacturer P/N
2	C1A, C1B	10 μ F	Ceramic capacitor, 100V, X7S	1210	Murata	GRM32EC72A106KE05L
1	C1C	0.1 μ F	Ceramic capacitor, 100V, X7R	0603	Murata	GRM188R72A104KA35D
2	C2A, C2B	22 μ F	Ceramic capacitor, 25V, X7R	1210	Murata	GRM32ER71E226KE15L
1	C3	1 μ F	Ceramic capacitor, 25V, X7R	0603	Murata	GRM188R71E105KA12D
1	C4	0.1 μ F	Ceramic capacitor, 16V, X7R	0603	Murata	GRM188R71C104KA01D
1	CIN5	22 μ F	Electrolytic capacitor, 63V	SMD	Jianghai	VTD-63V22
8	CIN1, CIN2, CIN3, CIN4, C2C, C2D, C2E, C5	NS				
1	D1	NS				
1	D2	5.6V	Zener diode	SOD323	Diodes, Inc.	BZT52C5V6S
1	FB1	NS				
1	L1	NS				
1	L2	15 μ H	Inductor, 35m Ω , DCR, 5.8A	SMD	MPS	MPL-AL6060-150
1	L3	Short		SMD		
3	R1, R9, R10	100k Ω	Film resistor, 1%	0603	Yageo	RC0603FR-07100KL
1	R3	10 Ω	Film resistor, 1%	0603	Yageo	RC0603FR-0710RL
1	R4	41.2k Ω	Film resistor, 1%	0603	Yageo	RC0603FR-0741K2L
1	R5	7.68k Ω	Film resistor, 1%	0603	Yageo	RC0603FR-077K68L
1	R6	20k Ω	Film resistor, 1%	0603	Yageo	RC0603FR-0720KL
1	R7	66.5k Ω	Film resistor, 1%	0603	Yageo	RC0603FR-0766K5L
1	R8	0 Ω	Film resistor, 1%	0603	Yageo	RC0603FR-070RL
1	R2	NS				
1	U1	MP4572	Step-down regulator	QFN-12 (2.5mmx3mm)	MPS	MP4572GQB
1	JP1	2.54mm	Test pin	DIP	Custom	
5	VIN, VEMI, VOUT, GND, GND	2mm	2 golden pins	DIP	Custom	
5	CCM/ SYNCO, PG, EN, GND, GND	2.54mm	Test pin	DIP	Custom	

EVB TEST RESULTS

Performance curves and waveforms are tested on the evaluation board. $V_{IN} = 24V$, $V_{OUT} = 5V$, $L = 15\mu H$, $f_{sw} = 450kHz$, $T_A = 25^\circ C$, unless otherwise noted.

Efficiency vs. Load Current vs. Power Loss

$V_{OUT} = 5V$, $f_{sw} = 450kHz$, $L = 15\mu H$, AAM

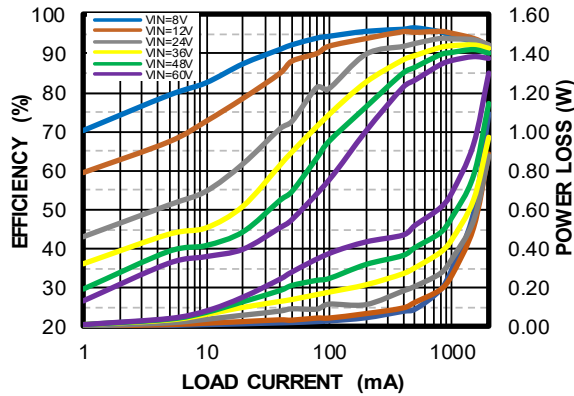

Efficiency vs. Load Current vs. Power Loss

$V_{OUT} = 5V$, $f_{sw} = 450kHz$, $L = 15\mu H$, FCCM

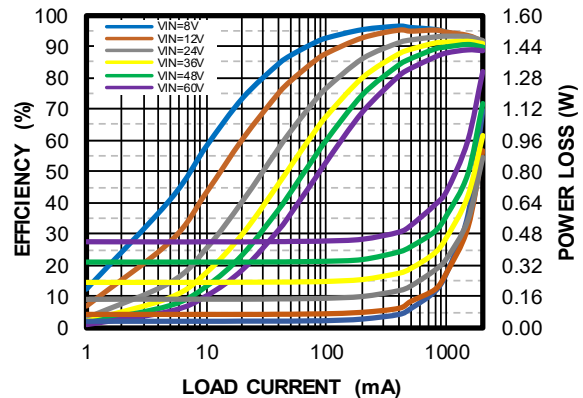

Efficiency vs. Load Current vs. Power Loss

$V_{OUT} = 5V$, $f_{sw} = 1MHz$, $L = 10\mu H$, AAM

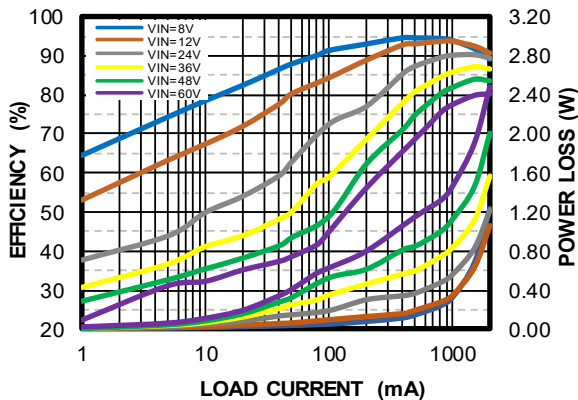

Efficiency vs. Load Current vs. Power Loss

$V_{OUT} = 5V$, $f_{sw} = 1MHz$, $L = 10\mu H$, FCCM

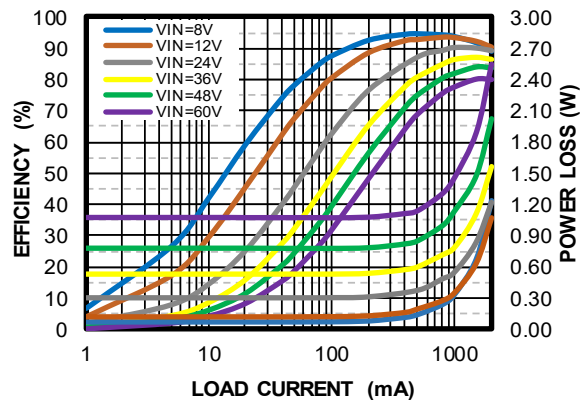

Efficiency vs. Load Current vs. Power Loss

$V_{OUT} = 5V$, $f_{sw} = 2.2MHz$, $L = 4.7\mu H$, AAM

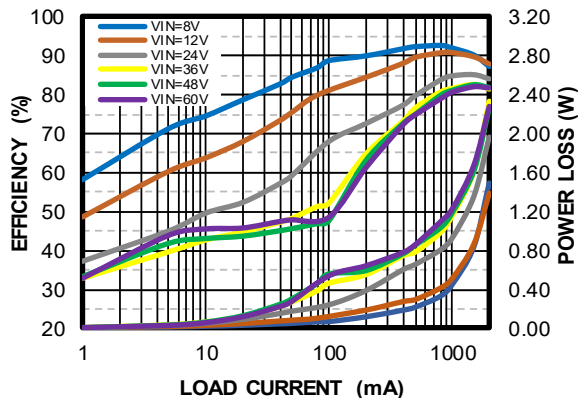

Efficiency vs. Load Current vs. Power Loss

$V_{OUT} = 5V$, $f_{sw} = 2.2MHz$, $L = 4.7\mu H$, FCCM

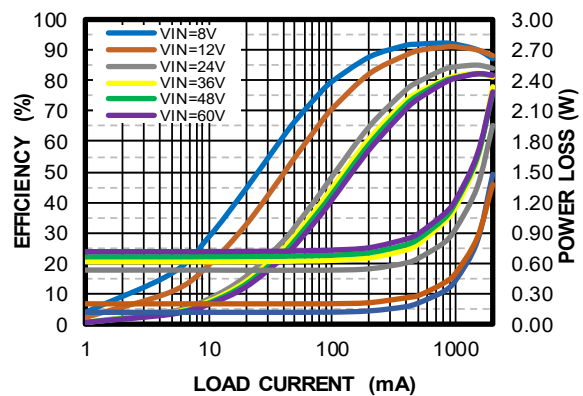

EVB TEST RESULTS (continued)

Performance curves and waveforms are tested on the evaluation board. $V_{IN} = 24V$, $V_{OUT} = 5V$, $L = 15\mu H$, $f_{SW} = 450kHz$, $T_A = 25^\circ C$, unless otherwise noted.

Start-Up through VIN

$I_{OUT} = 0A$, AAM

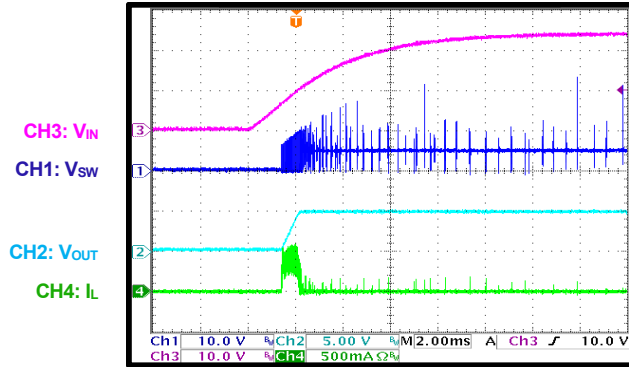

Start-Up through VIN

$I_{OUT} = 0A$, FCCM

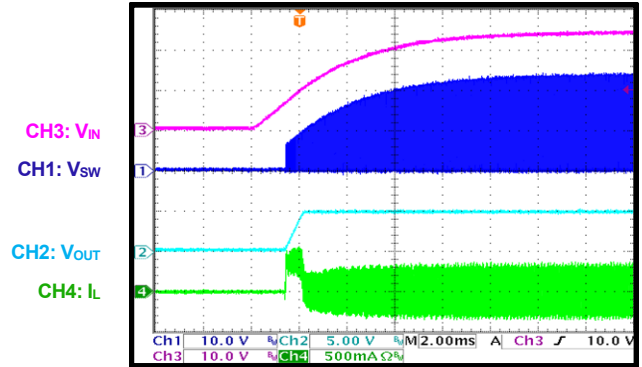

Start-Up through VIN

$I_{OUT} = 2A$, AAM

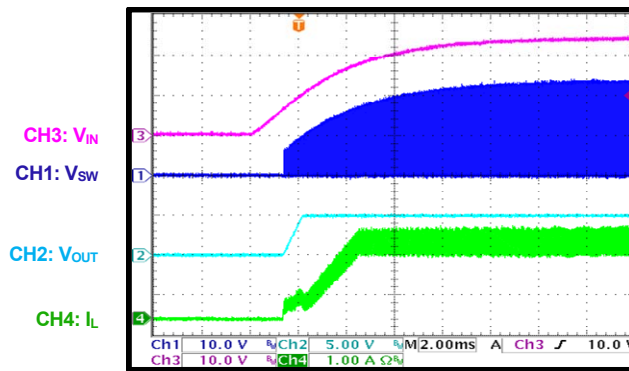

Start-Up through VIN

$I_{OUT} = 2A$, FCCM

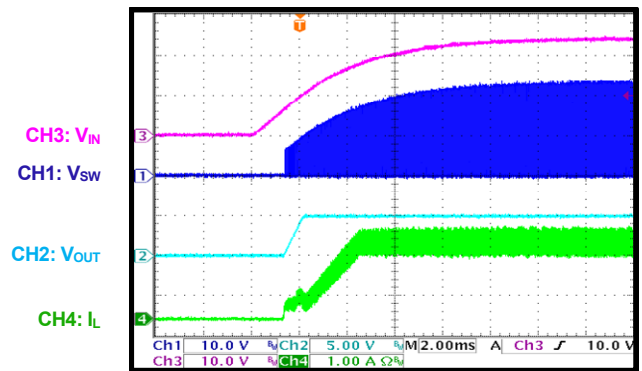

Shutdown through VIN

$I_{OUT} = 0A$, AAM

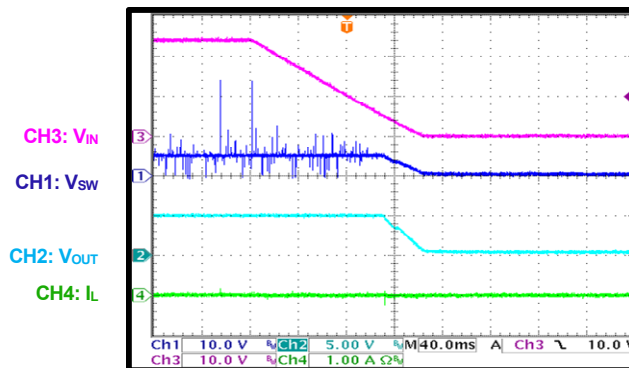

Shutdown through VIN

$I_{OUT} = 0A$, FCCM

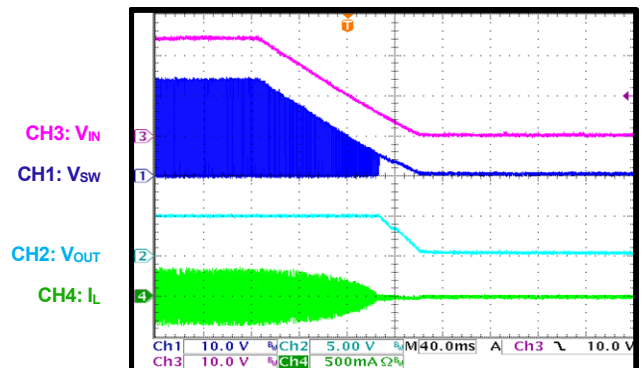

EVB TEST RESULTS (continued)

Performance curves and waveforms are tested on the evaluation board. $V_{IN} = 24V$, $V_{OUT} = 5V$, $L = 15\mu H$, $f_{SW} = 450kHz$, $T_A = 25^\circ C$, unless otherwise noted.

Shutdown through VIN

$I_{OUT} = 2A$, AAM

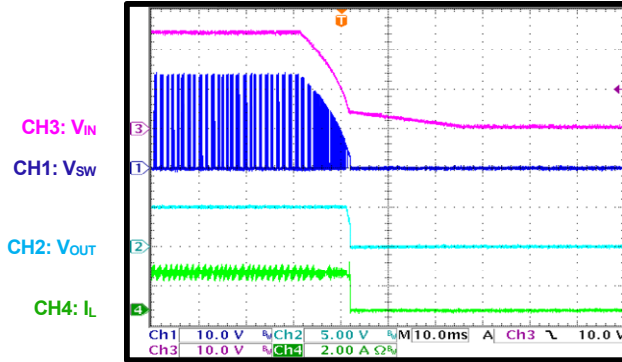

Shutdown through VIN

$I_{OUT} = 2A$, FCCM

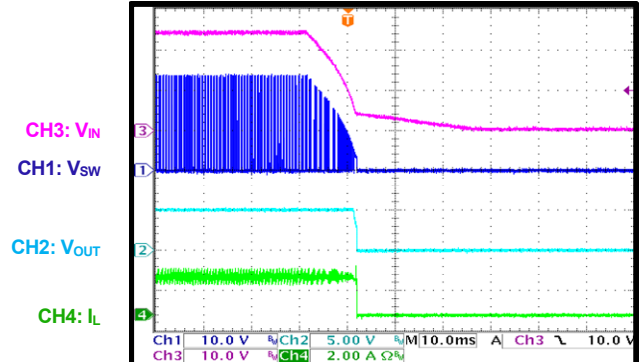

Start-Up through EN

$I_{OUT} = 0A$, AAM

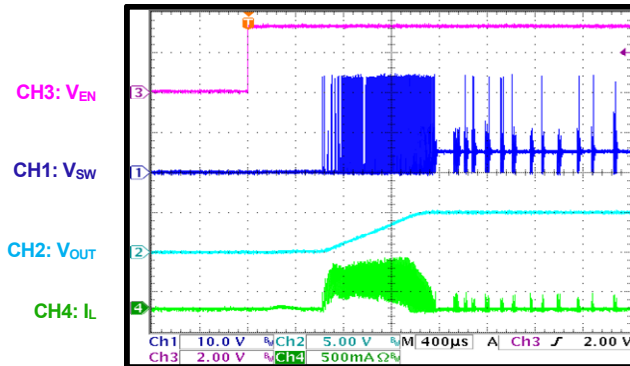

Start-Up through EN

$I_{OUT} = 0A$, FCCM

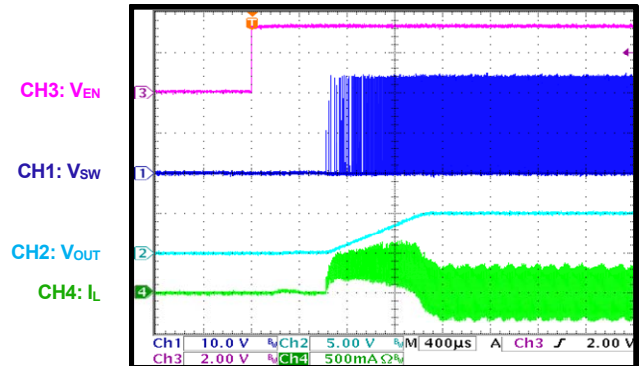

Start-Up through EN

$I_{OUT} = 2A$, AAM

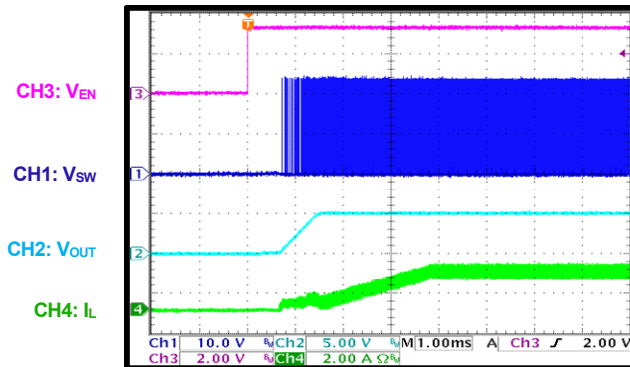

Start-Up through EN

$I_{OUT} = 2A$, FCCM

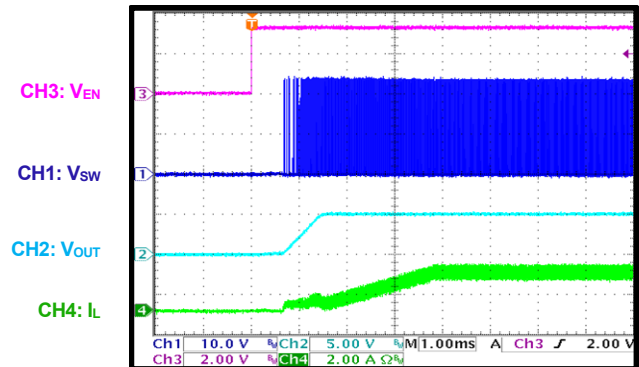

EVB TEST RESULTS (continued)

Performance curves and waveforms are tested on the evaluation board. $V_{IN} = 24V$, $V_{OUT} = 5V$, $L = 15\mu H$, $f_{SW} = 450kHz$, $T_A = 25^{\circ}C$, unless otherwise noted.

Shutdown through EN

$I_{OUT} = 0A$, AAM

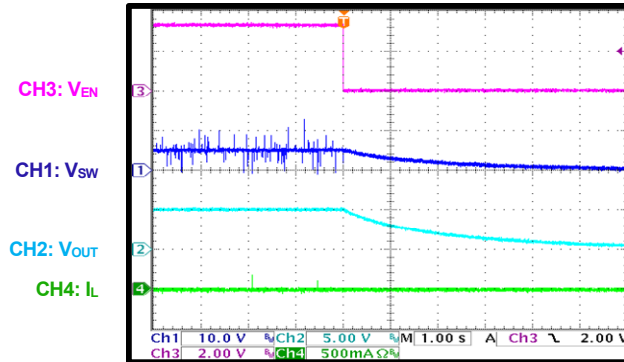

Shutdown through EN

$I_{OUT} = 0A$, FCCM

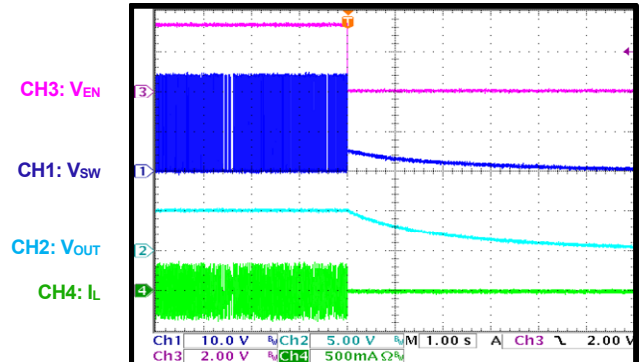

Start-Up through EN

$I_{OUT} = 2A$, AAM

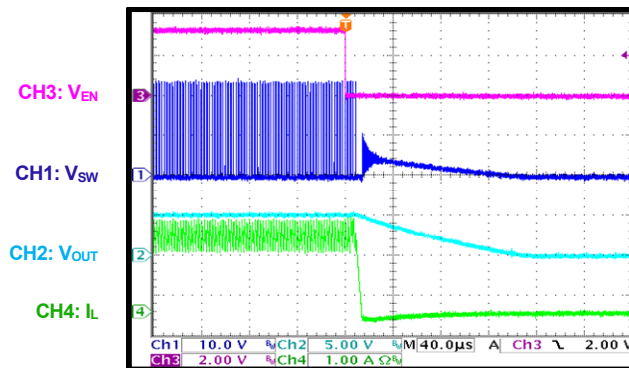

Shutdown through EN

$I_{OUT} = 2A$, FCCM

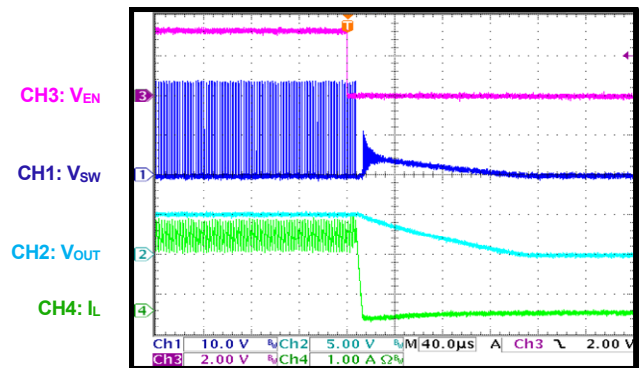

Output Ripple

$I_{OUT} = 0A$, AAM

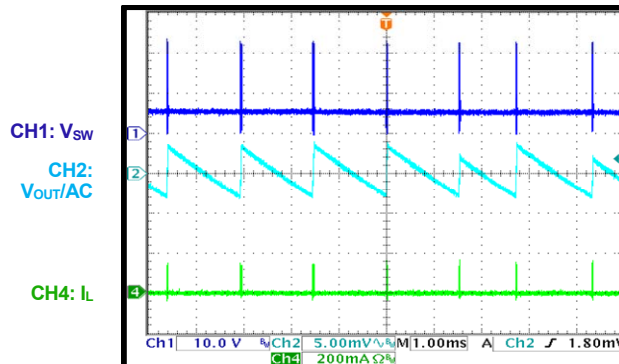

Output Ripple

$I_{OUT} = 0A$, FCCM

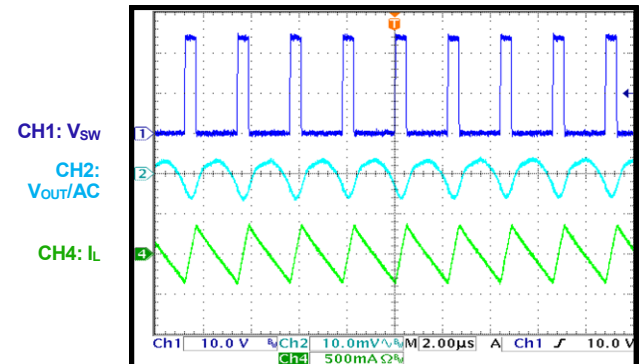

EVB TEST RESULTS (continued)

Performance curves and waveforms are tested on the evaluation board. $V_{IN} = 24V$, $V_{OUT} = 5V$, $L = 15\mu H$, $f_{SW} = 450kHz$, $T_A = 25^\circ C$, unless otherwise noted.

Output Ripple

$I_{OUT} = 2A$

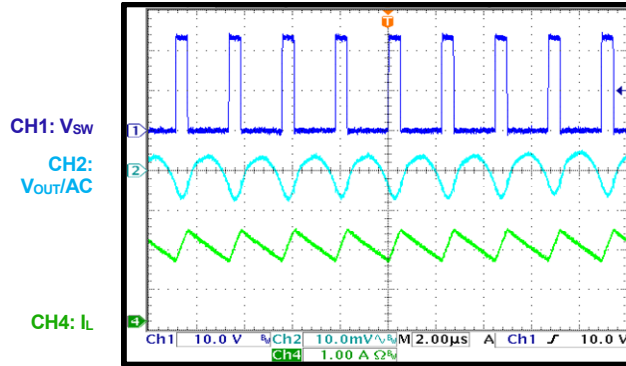

SCP Entry in AAM

$I_{OUT} = 0A$

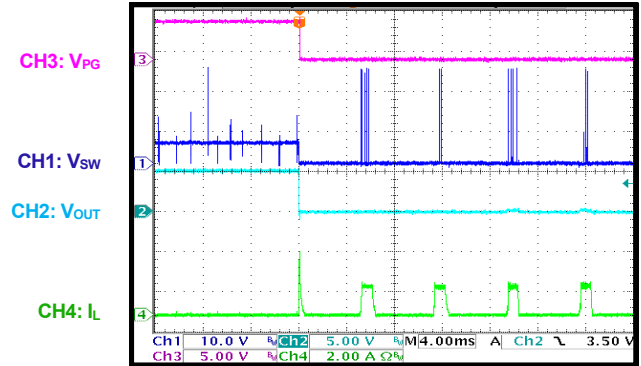

SCP Entry in FCCM

$I_{OUT} = 0A$

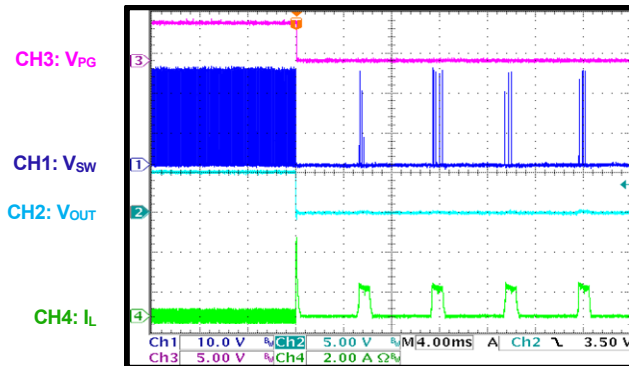

SCP Entry

$I_{OUT} = 2A$

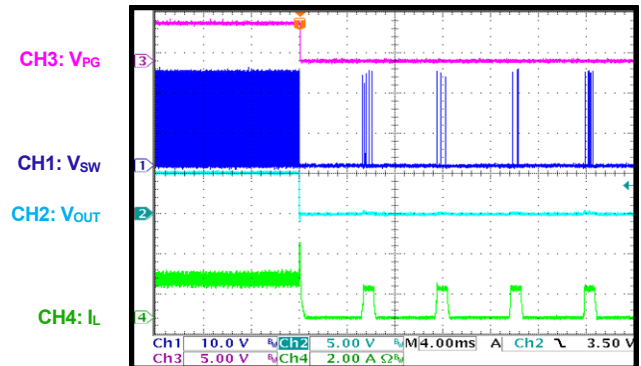

SCP Steady State

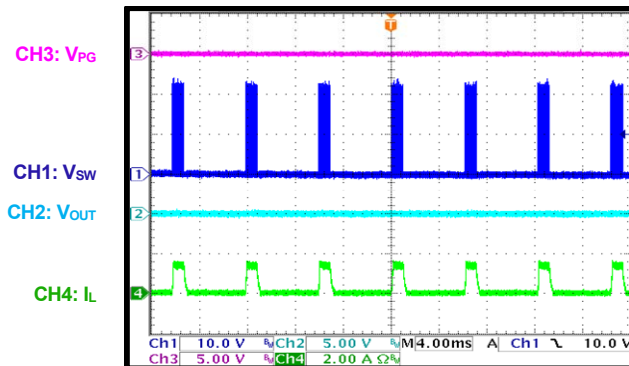

SCP Recovery in AAM

$I_{OUT} = 0A$

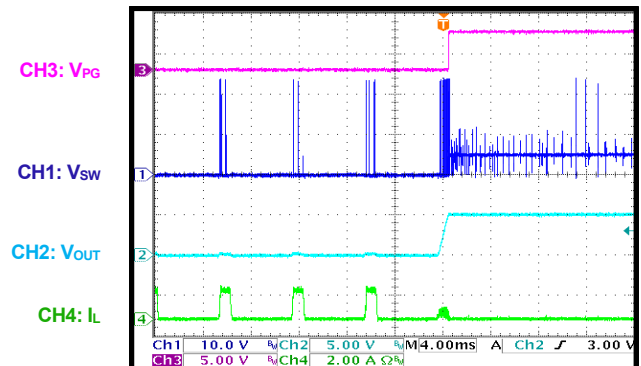

EVB TEST RESULTS (continued)

Performance curves and waveforms are tested on the evaluation board. $V_{IN} = 24V$, $V_{OUT} = 5V$, $L = 15\mu H$, $f_{SW} = 450kHz$, $T_A = 25^\circ C$, unless otherwise noted.

SCP Recovery in FCCM

$I_{OUT} = 0A$

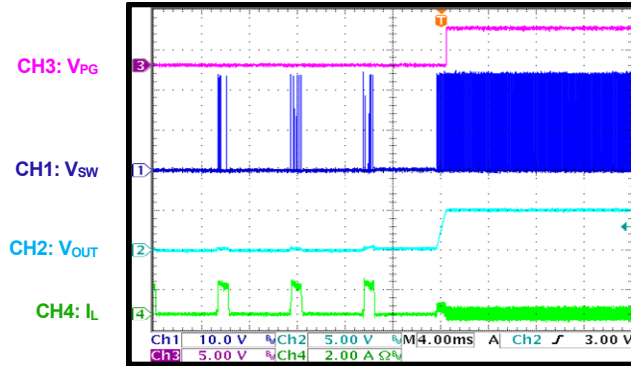

SCP Recovery

$I_{OUT} = 2A$

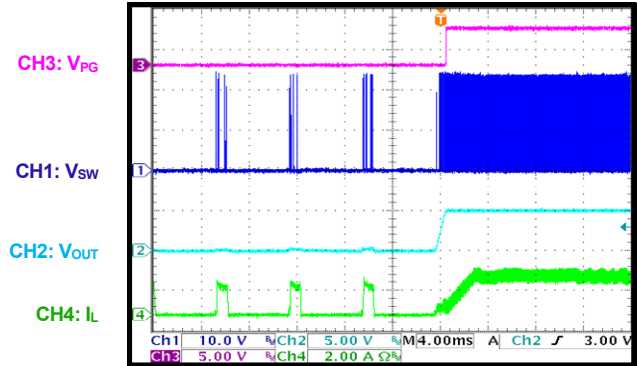

Load Transient

$I_{OUT} = 1A$ to $2A$

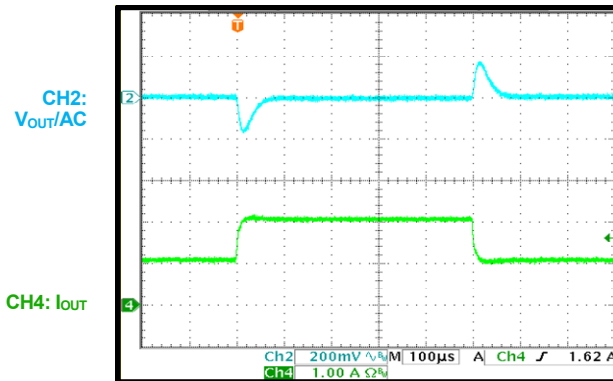

Cold Crank

$V_{IN} = 24V$ to $4V$ to $5V$, $I_{OUT} = 2A$

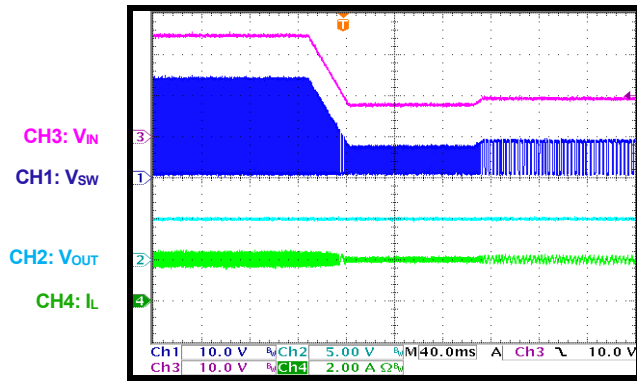

VIN Ramping Down and Up

$V_{IN} = 18V$ to $4.5V$ to $0V$ to $4.5V$ to $18V$, $I_{OUT} = 0A$, AAM

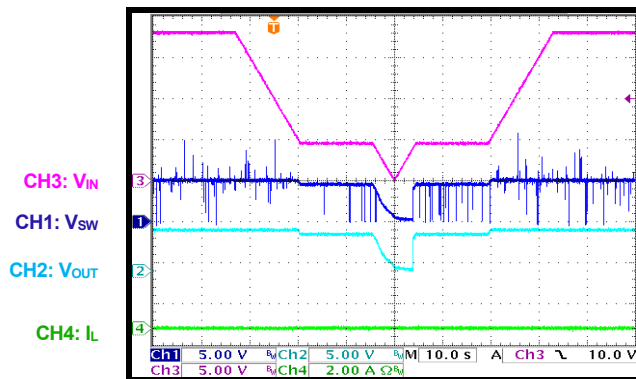

VIN Ramping Down and Up

$V_{IN} = 18V$ to $4.5V$ to $0V$ to $4.5V$ to $18V$, $I_{OUT} = 2A$

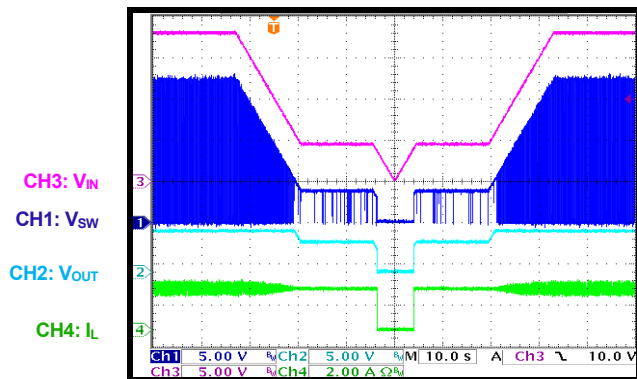

EVb TEST RESULTS (continued)

Performance curves and waveforms are tested on the evaluation board. $V_{IN} = 24V$, $V_{OUT} = 5V$, $L = 15\mu H$, $f_{SW} = 450kHz$, $T_A = 25^\circ C$, unless otherwise noted.

Load Dump

$V_{IN} = 24V$ to $48V$ to $24V$, $I_{OUT} = 2A$

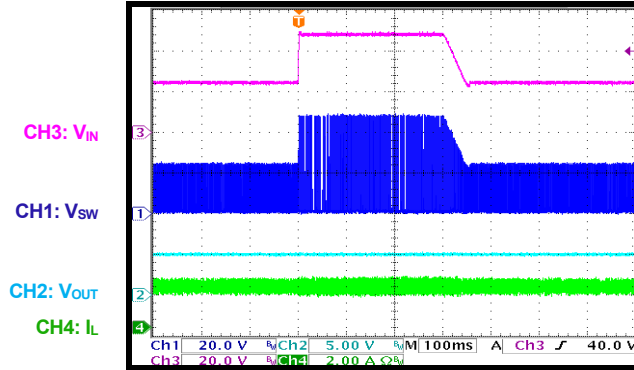

PCB LAYOUT

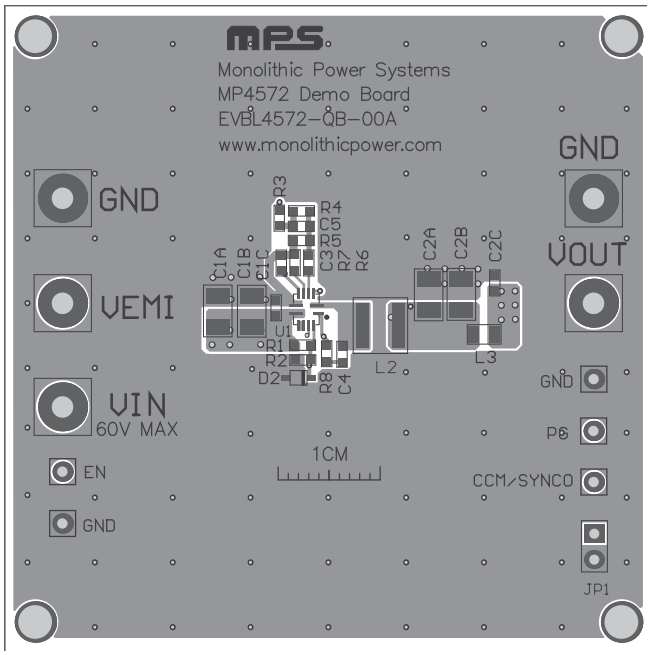

Figure 2: Top Silk and Top Layer

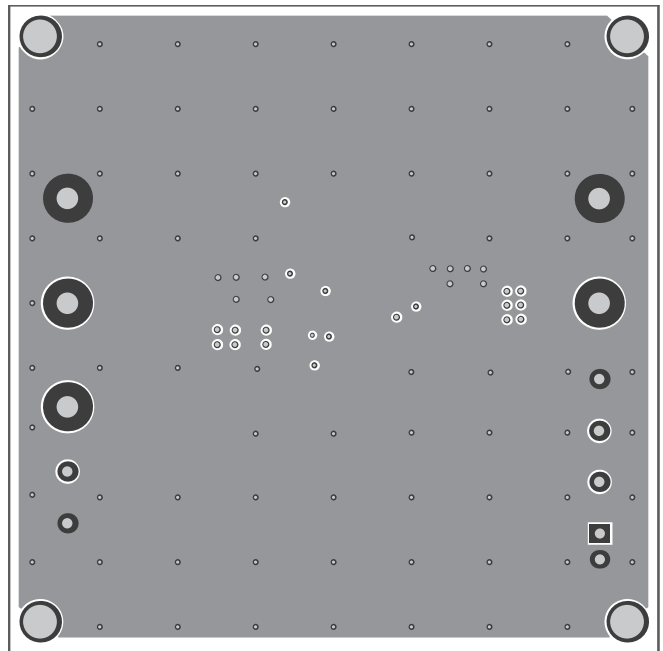

Figure 3: Mid-Layer 1

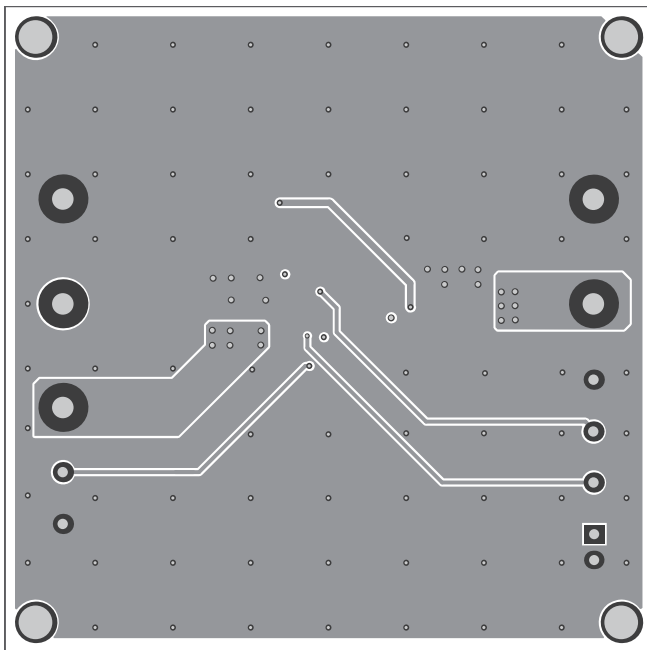

Figure 4: Mid-Layer 2

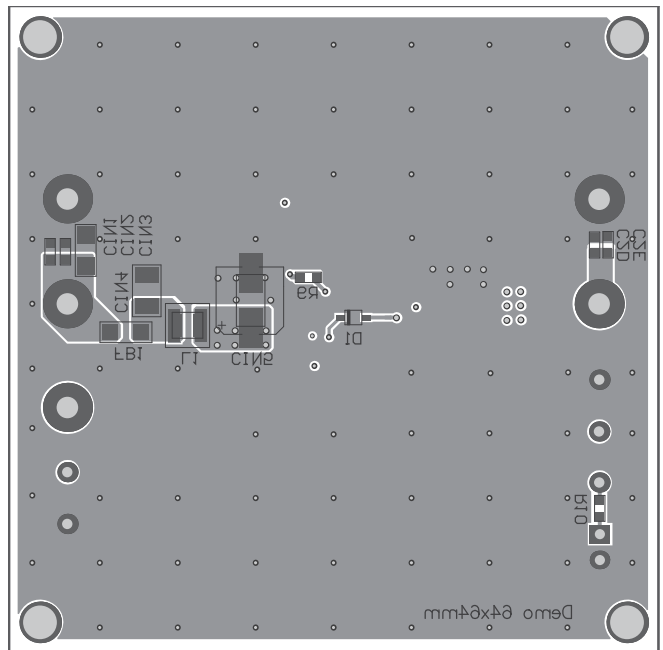

Figure 5: Bottom Layer and Bottom Silk



REVISION HISTORY

Revision #	Revision Date	Description	Pages Updated
1.0	2/4/2021	Initial Release	-

Notice: The information in this document is subject to change without notice. Please contact MPS for current specifications. Users should warrant and guarantee that third-party Intellectual Property rights are not infringed upon when integrating MPS products into any application. MPS will not assume any legal responsibility for any said applications.