

FL SWITCH 2406-2SFX PN - Industrial Ethernet Switch



1089126

<https://www.phoenixcontact.com/us/products/1089126>

Please be informed that the data shown in this PDF document is generated from our online catalog. Please find the complete data in the user documentation. Our general terms of use for downloads are valid.



Managed Switch 2000, 6 RJ45 ports 10/100 Mbps, 2 SFP ports 100 Mbps, PROFINET Conformance-Class B, Extended temperature range, PROFINET mode preset, PROFINET status LEDs

Your advantages

- MRP (client and manager)
- VLANs
- DHCP client, DHCP server (pool-based and port-based), DHCP option 82
- RSTP
- Ambient temperature -40 °C ... 70 °C
- Configuration memory
- Web-based management, SNMP
- PROFINET mode preset

Commercial data

Item number	1089126
Packing unit	1 pc
Minimum order quantity	1 pc
Sales key	DN17
Product key	DNN122
GTIN	4055626892368
Weight per piece (including packing)	806.1 g
Weight per piece (excluding packing)	650 g
Customs tariff number	85176200
Country of origin	DE

FL SWITCH 2406-2SFX PN - Industrial Ethernet Switch



1089126

<https://www.phoenixcontact.com/us/products/1089126>

Technical data

Dimensions

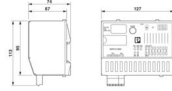
Dimensional drawing	
Width	128 mm
Height	113 mm
Depth	67 mm

Notes

General	Support by phone or on-site (fee is charged)
---------	--

Material specifications

Material base plate	Die-cast aluminum, corrosion-resistant
Housing material	Stainless steel 1.4301

Mounting

Mounting type	DIN rail mounting
---------------	-------------------

Interfaces

Ethernet (RJ45)

Connection method	RJ45
Note on the connection method	Auto negotiation and autocrossing
Transmission speed	10/100 Mbps
Transmission physics	Copper
Transmission length	100 m (per segment)
Signal LEDs	Data receive, link status
No. of channels	6 (RJ45 ports)

Ethernet (SFP)

Number of interfaces	2
Connection method	SFP
Transmission speed	100 Mbps (full duplex)
Transmission physics	Depending on the SFP module
Transmission length	up to 40 km (depending on the SFP module used)
Signal LEDs	Data receive, link status
No. of channels	2 (SFP ports)

Product properties

Product type	Switch
Product family	Managed Switch 2000
Type	Block design

FL SWITCH 2406-2SFX PN - Industrial Ethernet Switch



1089126

<https://www.phoenixcontact.com/us/products/1089126>

MTTF	357.82 Years (SN 29500 standard, temperature 25°C, operating cycle 21%)
	191.24 Years (SN 29500 standard, temperature 40°C, operating cycle 34.25%)
	25.65 Years (SN 29500 standard, temperature 70°C, operating cycle 100%)
Special properties	Extended temperature range
	PROFINET mode preset, PROFINET status LEDs
Signal delay	≥ 6.5 μs (Store and Forward mode, 10/100 Mbps, depending on the frame size)

Insulation characteristics

Protection class	III (VDE 0106)
Degree of pollution	2

Switch functions

Diagnostic functions	RMON History
	LLDP (Link Layer Discovery Protocol)
	SNMP-Traps
	N:1-Portmirroring
	ACD (Address Conflict Detection)
	SysLog
	CRC-Surveillance
Basic functions	Store-and-forward switch, complies with IEEE 802.3
Signal contact control voltage	typ. 24 V DC
PROFINET conformance class	Conformance-Class B
PROFINET device function	PROFINET device
	Fast Startup
Filter functions	Quality of Service (8 priority classes)
	Class of Service
	DiffServ/DSCP
	Port-Priorisierung
	VLAN (up to 32 VLANs)
	IGMP Snooping/Querier (v1/v2)
	Auto-Query-Port
	Extended Multicast Filtering
IP parameterization	DHCP-Client
	DHCP Option 82 (Relay Agent)
	DHCP server (pool-based, port-based)
	BootP
	DCP (Discovery and Configuration Protocol)
MAC address table	8k
Management	Web-based management (HTTP/HTTPS)
	Role-based user management (LDAP, RADIUS)
	SNMPv1/v2/v3
	Command Line Interface (Telnet, SSH)

FL SWITCH 2406-2SFX PN - Industrial Ethernet Switch



1089126

<https://www.phoenixcontact.com/us/products/1089126>

Redundancy	MRP (Media Redundancy Protocol)
	RSTP (Rapid Spanning Tree Protocol)
	FRD (Fast Ring Detection)
	Large Tree Support
	LACP (Link Aggregation Control Protocol)
	PROFINET S2 system redundancy
Status and diagnostic indicators	LEDs: US1, US2 (power supply), Fail (alarm contact), 2 LEDs per Ethernet port (link/activity and speed), PROFINET status LEDs (BF, SF)
Additional functions	Transmission of MMS and GOOSE (IEC 61850-8-1)
	Transmission of Modbus/TCP
Time synchronization	SNTP (Simple Network Time Protocol)
Security functions	
Port security	MAC-based, RADIUS (IEEE 802.1X), MAC Authentication Bypass
Basic functions	Store-and-forward switch, complies with IEEE 802.3

Electrical properties

Local diagnostics	US1/2 Supply voltage US1, US2 Green LED
	FAIL Div. LED red
	LNK/ACT Link status Green LED
	SPD Data transmission speed Green LED
	BF Bus errors LED red
	SF Group error LED red
Maximum power dissipation for nominal condition	4.7 W ($U_S = \max$, $T_{amb} = \max$)
Test voltage	500 V DC
Test section	for one minute 500 V DC
Transmission medium	Copper
	FO

Supply

Supply voltage (DC)	24 V DC (redundant)
Supply voltage range	19.2 V DC ... 32 V DC
Power supply connection	Via COMBICON, max. conductor cross section 2.5 mm ²
Residual ripple	3.6 V _{PP} (within the permitted voltage range)
Max. current consumption	250 mA ($U_S = \min$, $T_{amb} = \max$)
Typical current consumption	180 mA (at $U_S = 24$ V DC and 25 °C ambient temperature)

Function

Signal contact control voltage	typ. 24 V DC
--------------------------------	--------------

Connection data

Connection method	Push-in spring connection
Note on the connection method	Use only copper connecting cables providing the permitted temperature range (-40 °C ... 75 °C).
Conductor cross section, rigid	0.2 mm ² ... 1.5 mm ²

FL SWITCH 2406-2SFX PN - Industrial Ethernet Switch



1089126

<https://www.phoenixcontact.com/us/products/1089126>

Conductor cross section, flexible	0.2 mm ² ... 2.5 mm ²
Conductor cross section AWG	24 ... 16
Stripping length	10 mm

Environmental and real-life conditions

Ambient conditions

Degree of protection	IP20
Ambient temperature (operation)	-40 °C ... 70 °C
Ambient temperature (storage/transport)	-40 °C ... 85 °C
Permissible humidity (operation)	10 % ... 95 % (non-condensing)
Permissible humidity (storage/transport)	10 % ... 95 % (non-condensing)
Shock (operation)	30g (EN 60068-2-27)
Vibration (operation)	in acc. with IEC 60068-2-6: 5g, 150 Hz
Air pressure (operation)	79 kPa ... 108 kPa up to 2000 m above mean sea level (Without derating)
Air pressure (storage/transport)	79 kPa ... 108 kPa up to 2000 m above mean sea level (Without derating)

Standards and regulations

Free from substances that could impair the application of coating	Yes
---	-----

Approvals

UL, USA/Canada

Identification	cULus
----------------	-------

Corrosive gas test

Identification	ISA S71.04.2013 G3 Harsh Group A
----------------	----------------------------------

DNV GL data

Temperature	B
Humidity	B
Vibration	A
EMC	B
Enclosure	Required protection according to the Rules shall be provided upon installation on board

EMC data

Conformance with EMC directives	EN 61000-6-2 EN 61000-4-2 (ESD) Criterion B
	EN 61000-6-2 EN 61000-4-3 (electromagnetic fields) Criterion A
	EN 61000-6-2 EN 61000-4-4 (EFT burst) Criterion A
	EN 61000-6-2 EN 61000-4-5 (surge) Criterion A
	EN 61000-6-2 EN 61000-4-6 (line noise immunity) Criterion A
	EN 61000-6-2 EN 61000-6-4 (interference) Class A
	EN 61000-6-2 EN 61000-6-4 (conducted interference) Class A
Noise immunity	EN 61000-6-2

FL SWITCH 2406-2SFX PN - Industrial Ethernet Switch



1089126

<https://www.phoenixcontact.com/us/products/1089126>

Electromagnetic compatibility	Conformance with EMC Directive 2014/30/EU
Noise emission	EN 61000-6-4

System properties

Functionality

Basic functions	Store-and-forward switch, complies with IEEE 802.3
-----------------	--

Signaling

Status display	LEDs: US1, US2 (power supply), Fail (alarm contact), 2 LEDs per Ethernet port (link/activity and speed), PROFINET status LEDs (BF, SF)
----------------	--

FL SWITCH 2406-2SFX PN - Industrial Ethernet Switch



1089126

<https://www.phoenixcontact.com/us/products/1089126>

Drawings

Connection diagram

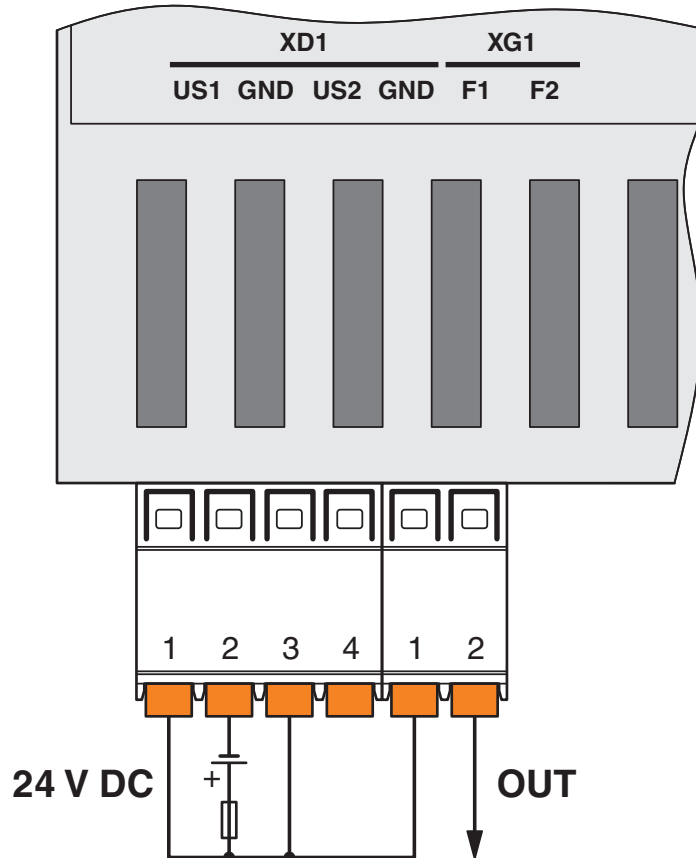

Dimensional drawing

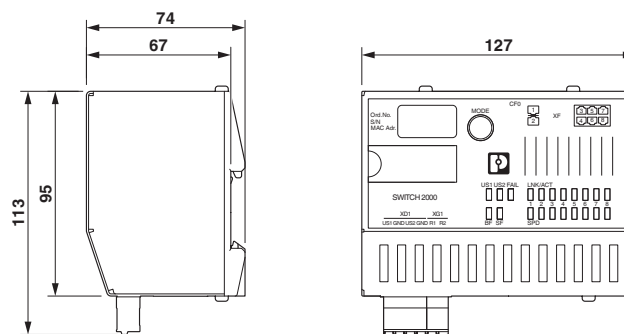

FL SWITCH 2406-2SFX PN - Industrial Ethernet Switch



1089126

<https://www.phoenixcontact.com/us/products/1089126>

Connection diagram

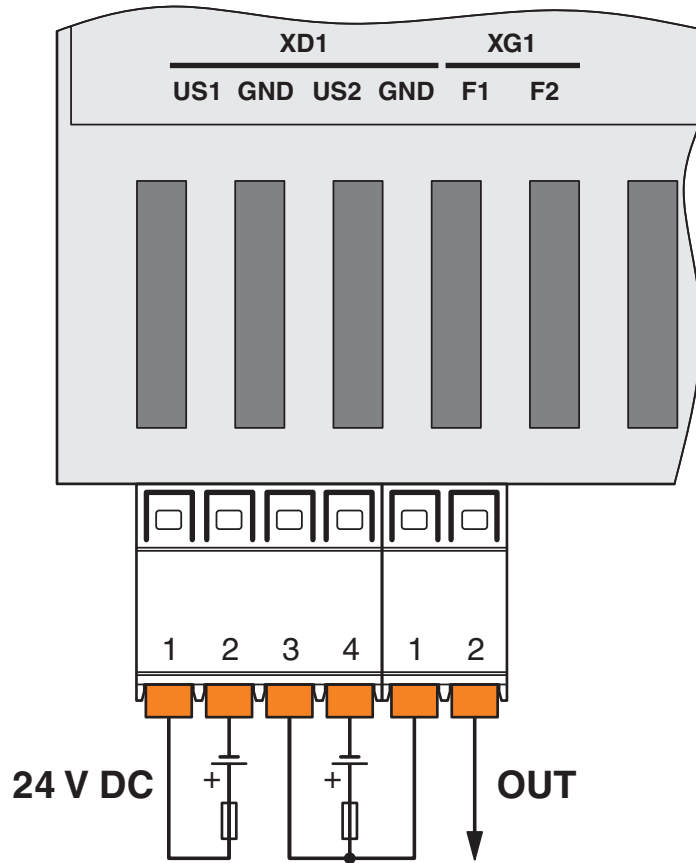

FL SWITCH 2406-2SFX PN - Industrial Ethernet Switch



1089126

<https://www.phoenixcontact.com/us/products/1089126>

Approvals

To download certificates, visit the product detail page: <https://www.phoenixcontact.com/us/products/1089126>



DNV GL

Approval ID: TAA00000YV



LR

Approval ID: LR22250919TA



BV

Approval ID: 48146/A1 BV

BSH

Approval ID: 1045

ABS

Approval ID: 21_2066186_1_PDA

PROFINET

Approval ID: Z12636



RINA

Approval ID: ELE014724XG001



cULus Listed

Approval ID: E238705

FL SWITCH 2406-2SFX PN - Industrial Ethernet Switch



1089126

<https://www.phoenixcontact.com/us/products/1089126>

Classifications

ECLASS

ECLASS-11.0	19170401
ECLASS-12.0	19170401
ECLASS-13.0	19170401

ETIM

ETIM 9.0	EC000734
----------	----------

UNSPSC

UNSPSC 21.0	43222600
-------------	----------

FL SWITCH 2406-2SFX PN - Industrial Ethernet Switch



1089126

<https://www.phoenixcontact.com/us/products/1089126>

Environmental product compliance

EU RoHS

Fulfills EU RoHS substance requirements	Yes
Exemption	7(a), 7(c)-I

China RoHS

Environment friendly use period (EFUP)	EFUP-50
	An article-related China RoHS declaration table can be found in the download area for the respective article under "Manufacturer declaration". For all articles with EFUP-E, no China RoHS declaration table issued and required.

EU REACH SVHC

REACH candidate substance (CAS No.)	Lead(CAS: 7439-92-1)
SCIP	637b635d-f0b8-4295-9fa7-2fc277b24ced

FL SWITCH 2406-2SFX PN - Industrial Ethernet Switch



1089126

<https://www.phoenixcontact.com/us/products/1089126>

Accessories

SD FLASH 2GB - Program / configuration memory

2988162

<https://www.phoenixcontact.com/us/products/2988162>



Program and configuration memory, for extending the internal flash memory, pluggable, 2 GB.

FL NETWORK MANAGER BASIC - Network management software

2702889

<https://www.phoenixcontact.com/us/products/2702889>



SNMP-based software for easy commissioning and monitoring of network components such as switches, routers, and WLAN access points

FL SWITCH 2406-2SFX PN - Industrial Ethernet Switch



1089126

<https://www.phoenixcontact.com/us/products/1089126>

FL DIN RA - DIN rail adapter

2891053

<https://www.phoenixcontact.com/us/products/2891053>

The FL DIN RA is installed in a standard, 19-inch rack (EIA-310-D, IEC 60297-3-100) to allow DIN rail mounted equipment to be rack mounted.



FL RJ45 PROTECT CAP - Dust protection

2832991

<https://www.phoenixcontact.com/us/products/2832991>

Dust protection caps for RJ45 socket

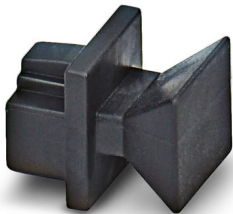

FL SWITCH 2406-2SFX PN - Industrial Ethernet Switch



1089126

<https://www.phoenixcontact.com/us/products/1089126>

E/NS 35 N - End bracket

0800886

<https://www.phoenixcontact.com/us/products/0800886>

End clamp, width: 9.5 mm, color: gray

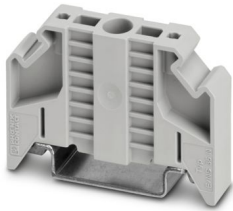

FL CAT5 PATCH 0,5 - Patch cable

2832263

<https://www.phoenixcontact.com/us/products/2832263>

Patch cable, CAT5, assembled, 0.5 m



FL SWITCH 2406-2SFX PN - Industrial Ethernet Switch



1089126

<https://www.phoenixcontact.com/us/products/1089126>

FL CAT5 PATCH 1,0 - Patch cable

2832276

<https://www.phoenixcontact.com/us/products/2832276>

Patch cable, CAT5, assembled, 1 m



FL CAT5 PATCH 2,0 - Patch cable

2832289

<https://www.phoenixcontact.com/us/products/2832289>

Patch cable, CAT5, assembled, 2 m



FL SWITCH 2406-2SFX PN - Industrial Ethernet Switch



1089126

<https://www.phoenixcontact.com/us/products/1089126>

NBC-R4AC-R4AC-IE8A/.../... - Patch cable

1411854

<https://www.phoenixcontact.com/us/products/1411854>

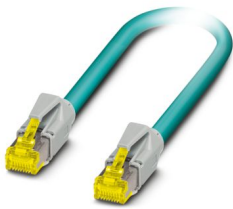

Patch cable, degree of protection: IP20, number of positions: 8, 10 Gbps, CAT6_A, cable outlet: straight, Ethernet

NBC-R4AC/10G-R4AC/10G-94F/2,0 - Patch cable

1408360

<https://www.phoenixcontact.com/us/products/1408360>

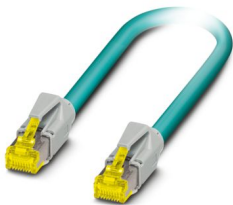

Patch cable, CAT6_A, 4-pair, shielded, connection not crossed (line), assembled at both ends with RJ45/IP20 connectors, outer sheath material: PUR, length: 2.0 m

FL SWITCH 2406-2SFX PN - Industrial Ethernet Switch



1089126

<https://www.phoenixcontact.com/us/products/1089126>

NBC-R4AC/10G-R4AC/10G-94F/3,0 - Patch cable

1408365

<https://www.phoenixcontact.com/us/products/1408365>

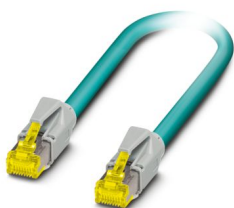

Patch cable, CAT6_A, 4-pair, shielded, connection not crossed (line), assembled at both ends with RJ45/IP20 connectors, outer sheath material: PUR, length: 3.0 m

NBC-R4AC/1,0-93B/R4AC - Patch cable

1408968

<https://www.phoenixcontact.com/us/products/1408968>



Patch cable, degree of protection: IP20, cable length: 1 m, number of positions: 4, 100 Mbps, CAT5, material: PA 6.6, PROFINET

FL SWITCH 2406-2SFX PN - Industrial Ethernet Switch



1089126

<https://www.phoenixcontact.com/us/products/1089126>

NBC-R4AC/2,0-93B/R4AC - Patch cable

1408969

<https://www.phoenixcontact.com/us/products/1408969>



Patch cable, degree of protection: IP20, cable length: 2 m, number of positions: 4, 100 Mbps, CAT5, material: PA 6.6, PROFINET

NBC-R4AC/5,0-93B/R4AC - Patch cable

1408970

<https://www.phoenixcontact.com/us/products/1408970>



Patch cable, degree of protection: IP20, cable length: 5 m, number of positions: 4, 100 Mbps, CAT5, material: PA 6.6, PROFINET

FL SWITCH 2406-2SFX PN - Industrial Ethernet Switch



1089126

<https://www.phoenixcontact.com/us/products/1089126>

FKCN 2,5/ 2-ST GY7035 BD:1-2 - PCB connector

1082048

<https://www.phoenixcontact.com/us/products/1082048>

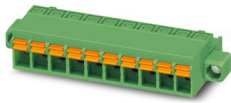

PCB connector, nominal cross section: 2.5 mm², color: light grey, nominal current: 12 A, rated voltage (III/2): 320 V, contact surface: Tin, contact connection type: Socket, number of rows: 1, number of positions: 2, product range: FKCN 2,5/...-ST, pitch: 5 mm, connection method: Push-in spring connection, conductor/PCB connection direction: 0 °, locking clip: - Locking clip, plug-in system: COMBICON MSTB 2,5, locking: Screw locking mechanism, mounting: Screw flange, type of packaging: packed in cardboard

FKCN 2,5/ 4-ST GY7035 BD:1-4 - PCB connector

1082059

<https://www.phoenixcontact.com/us/products/1082059>

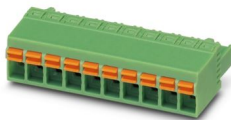

PCB connector, nominal cross section: 2.5 mm², color: light grey, nominal current: 12 A, rated voltage (III/2): 320 V, contact surface: Tin, contact connection type: Socket, number of rows: 1, number of positions: 4, product range: FKCN 2,5/...-ST, pitch: 5 mm, connection method: Push-in spring connection, conductor/PCB connection direction: 0 °, locking clip: - Locking clip, plug-in system: COMBICON MSTB 2,5, locking: without, mounting: without, type of packaging: packed in cardboard

FL SWITCH 2406-2SFX PN - Industrial Ethernet Switch



1089126

<https://www.phoenixcontact.com/us/products/1089126>

FL SFP FX - Media module

2891081

<https://www.phoenixcontact.com/us/products/2891081>



The small form-factor plug-in module provides a fiber optic interface with a data transmission speed of 100 Mbps with a wavelength of 1310 nm (long).

FL SFP FX SM - Media module

2891082

<https://www.phoenixcontact.com/us/products/2891082>



The small form-factor plug-in module provides a fiber optic interface with a data transmission speed of 100 Mbps with a wavelength of 1310 nm (long).

FL SWITCH 2406-2SFX PN - Industrial Ethernet Switch



1089126

<https://www.phoenixcontact.com/us/products/1089126>

FL SFP FE WDM20-SET - Media module

2702439

<https://www.phoenixcontact.com/us/products/2702439>

Fast Ethernet SFP WDM set for transmission up to a maximum of 20 km on a single fiber with a wavelength of 1310/1550 nm.



FOC-LC:PA-SC:PA-OM2:D01/1 - FO patch cable

1115607

<https://www.phoenixcontact.com/us/products/1115607>

Multi-mode OM2 duplex jumper, LC-SC, UPC polishing, length 1 m

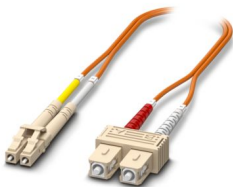

FL SWITCH 2406-2SFX PN - Industrial Ethernet Switch



1089126

<https://www.phoenixcontact.com/us/products/1089126>

FOC-LC:PA-SC:PA-OM2:D01/2 - FO patch cable

1115605

<https://www.phoenixcontact.com/us/products/1115605>

Multi-mode OM2 duplex jumper, LC-SC, UPC polishing, length 2 m

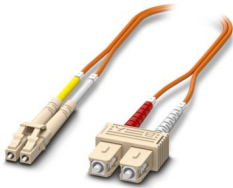

FOC-LC:PA-LC:PA-OM2:D01/1 - FO patch cable

1115633

<https://www.phoenixcontact.com/us/products/1115633>

Multi-mode OM2 duplex jumper, LC-LC, UPC polishing, length 1 m

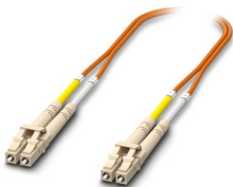

FL SWITCH 2406-2SFX PN - Industrial Ethernet Switch



1089126

<https://www.phoenixcontact.com/us/products/1089126>

FOC-LC:PA-LC:PA-OM2:D01/2 - FO patch cable

1115634

<https://www.phoenixcontact.com/us/products/1115634>

Multi-mode OM2 duplex jumper, LC-LC, UPC polishing, length 2 m

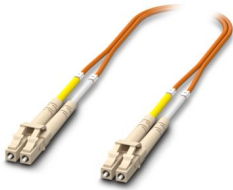

FOC-LC:PA-ST:PA-OM2:D01/1 - Fiber optic cable

1115588

<https://www.phoenixcontact.com/us/products/1115588>

Multi-mode OM2 duplex jumper, LC-ST, UPC polishing, length 1 m

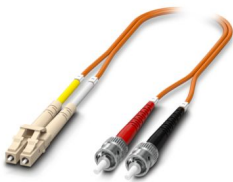

FL SWITCH 2406-2SFX PN - Industrial Ethernet Switch



1089126

<https://www.phoenixcontact.com/us/products/1089126>

FOC-LC:PA-ST:PA-OM2:D01/2 - Fiber optic cable

1115587

<https://www.phoenixcontact.com/us/products/1115587>

Multi-mode OM2 duplex jumper, LC-ST, UPC polishing, length 2 m

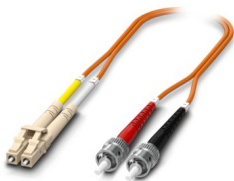

FOC-LC:PA-SC:PA-OM4:D01/1 - FO patch cable

1115601

<https://www.phoenixcontact.com/us/products/1115601>

Multi-mode OM4 duplex jumper, LC-SC, UPC polishing, length 1 m

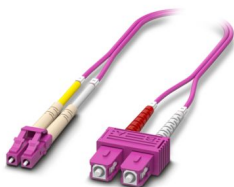

FL SWITCH 2406-2SFX PN - Industrial Ethernet Switch



1089126

<https://www.phoenixcontact.com/us/products/1089126>

FOC-LC:PA-SC:PA-OM4:D01/2 - FO patch cable

1115600

<https://www.phoenixcontact.com/us/products/1115600>

Multi-mode OM4 duplex jumper, LC-SC, UPC polishing, length 2 m

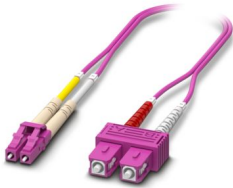

FOC-LC:PA-LC:PA-OM4:D01/1 - FO patch cable

1115625

<https://www.phoenixcontact.com/us/products/1115625>

Multi-mode OM4 duplex jumper, LC-LC, UPC polishing, length 1 m

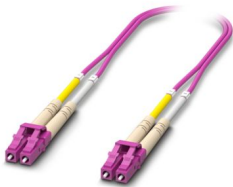

FL SWITCH 2406-2SFX PN - Industrial Ethernet Switch



1089126

<https://www.phoenixcontact.com/us/products/1089126>

FOC-LC:PA-LC:PA-OM4:D01/2 - FO patch cable

1115624

<https://www.phoenixcontact.com/us/products/1115624>

Multi-mode OM4 duplex jumper, LC-LC, UPC polishing, length 2 m

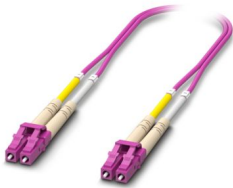

FOC-LC:PA-LC:PA-OS2:D01/1 - FO patch cable

1115636

<https://www.phoenixcontact.com/us/products/1115636>

Single-mode OS2 duplex jumper, LC-LC, UPC polishing, length 1 m



FL SWITCH 2406-2SFX PN - Industrial Ethernet Switch



1089126

<https://www.phoenixcontact.com/us/products/1089126>

FOC-LC:PA-LC:PA-OS2:D01/2 - FO patch cable

1115629

<https://www.phoenixcontact.com/us/products/1115629>

Single-mode OS2 duplex jumper, LC-LC, UPC polishing, length 2 m



FOC-LC:PA-ST:PA-OS2:D01/1 - FO patch cable

1115596

<https://www.phoenixcontact.com/us/products/1115596>

Single-mode OS2 duplex jumper, LC-ST, UPC polishing, length 1 m



FL SWITCH 2406-2SFX PN - Industrial Ethernet Switch



1089126

<https://www.phoenixcontact.com/us/products/1089126>

FOC-LC:PA-ST:PA-OS2:D01/2 - FO patch cable

1115595

<https://www.phoenixcontact.com/us/products/1115595>

Single-mode OS2 duplex jumper, LC-ST, UPC polishing, length 2 m



FOC-LC:PA-SC:PA-OS2:D01/1 - FO patch cable

1115618

<https://www.phoenixcontact.com/us/products/1115618>

Single-mode OS2 duplex jumper, LC-SC, UPC polishing, length 1 m

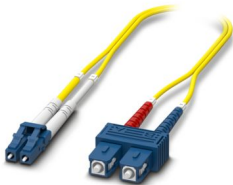

FL SWITCH 2406-2SFX PN - Industrial Ethernet Switch



1089126

<https://www.phoenixcontact.com/us/products/1089126>

FOC-LC:PA-SC:PA-OS2:D01/2 - FO patch cable

1115617

<https://www.phoenixcontact.com/us/products/1115617>

Single-mode OS2 duplex jumper, LC-SC, UPC polishing, length 2 m

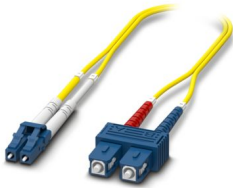

VS-08-RJ45-5-Q/IP20 - RJ45 connector

1656725

<https://www.phoenixcontact.com/us/products/1656725>



RJ45 connector, design: RJ45, degree of protection: IP20, number of positions: 8, 1 Gbps, CAT5, material: Plastic, connection method: Insulation displacement connection, connection cross section: AWG 26- 23, cable outlet: straight, color: traffic grey A RAL 7042, Ethernet

Phoenix Contact 2024 © - all rights reserved
<https://www.phoenixcontact.com>

Phoenix Contact USA
586 Fulling Mill Road
Middletown, PA 17057, United States
(+717) 944-1300
info@phoenixcon.com