

DFLK 50 - Interface module



2280284

<https://www.phoenixcontact.com/us/products/2280284>

Please be informed that the data shown in this PDF document is generated from our online catalog. Please find the complete data in the user documentation. Our general terms of use for downloads are valid.



The VARIOFACE feed-through module implements a 1:1 connection between screw connection terminal blocks and an IDC/FLK pin strip (2.54 mm, number of positions: 50).

Commercial data

Item number	2280284
Packing unit	5 pc
Minimum order quantity	5 pc
Note	Made to order (non-returnable)
Sales key	C422
Product key	CK2215
Catalog page	Page 582 (C-7-2015)
GTIN	4017918054397
Weight per piece (including packing)	155.4 g
Weight per piece (excluding packing)	155.4 g
Customs tariff number	85369010
Country of origin	DE

DFLK 50 - Interface module



2280284

<https://www.phoenixcontact.com/us/products/2280284>

Technical data

Product properties

Product type	Interface module
Product family	VARIOFACE
Number of positions	50
Operating mode	100% operating factor

Insulation characteristics

Insulation	Functional insulation
------------	-----------------------

Insulation characteristics: Air clearances and creepage distances

Insulation	Functional insulation
Overvoltage category	II
Pollution degree	2

Electrical properties

Operating voltage (AC)	≤ 30 V AC
Operating voltage (DC)	≤ 60 V DC
Current (per branch)	≤ 1 A
Current (Total current)	≤ 50 A (50 °C)

Air clearances and creepage distances

Rated insulation voltage	63 V
Rated surge voltage	0.6 kV (1.2/50 μs)

Connection data

Connection 1 (control level)

Connection in acc. with standard	IEC 60603-13
Connection method	IDC/FLK pin strip
Number of connections	1
Number of positions	50
Insertion/withdrawal cycles	> 50
Pitch	2.54 mm

Connection 2 (field level)

Connection method	Screw connection
Stripping length	8 mm
Screw thread	M3
Number of positions	50
Conductor cross section rigid	0.2 mm ² ... 4 mm ²
Conductor cross section flexible	0.2 mm ² ... 2.5 mm ²
Conductor cross section AWG	24 ... 12

Signaling

DFLK 50 - Interface module



2280284

<https://www.phoenixcontact.com/us/products/2280284>

Status display present	No
------------------------	----

Dimensions

Item dimensions

Width	39.88 mm
Height	143.4 mm
Depth	47.14 mm

Material specifications

Color	gray (RAL 7042)
Housing insulation material	Polyamide 6.6 green

Environmental and real-life conditions

Ambient conditions

Degree of protection (Module)	IP20
Degree of protection (Installation location)	≥ IP54
Ambient temperature (operation)	-20 °C ... 50 °C
Ambient temperature (storage/transport)	-20 °C ... 70 °C
Altitude	≤ 2000 m

Approvals

UKCA

Certificate	UKCA-compliant
-------------	----------------

Standards and regulations

Air clearances and creepage distances

Standards/regulations	EN IEC 60664-1
-----------------------	----------------

Mounting

Mounting type	Rear mounting
Mounting position	any

Notes

General	For proper use, the specifications of the installation directive (see Downloads) must be observed. For applications or use with third-party products, the specifications, and the safety and warning instructions of the respective third-party manufacturer must also be met.
---------	--

DFLK 50 - Interface module

2280284

<https://www.phoenixcontact.com/us/products/2280284>

Drawings

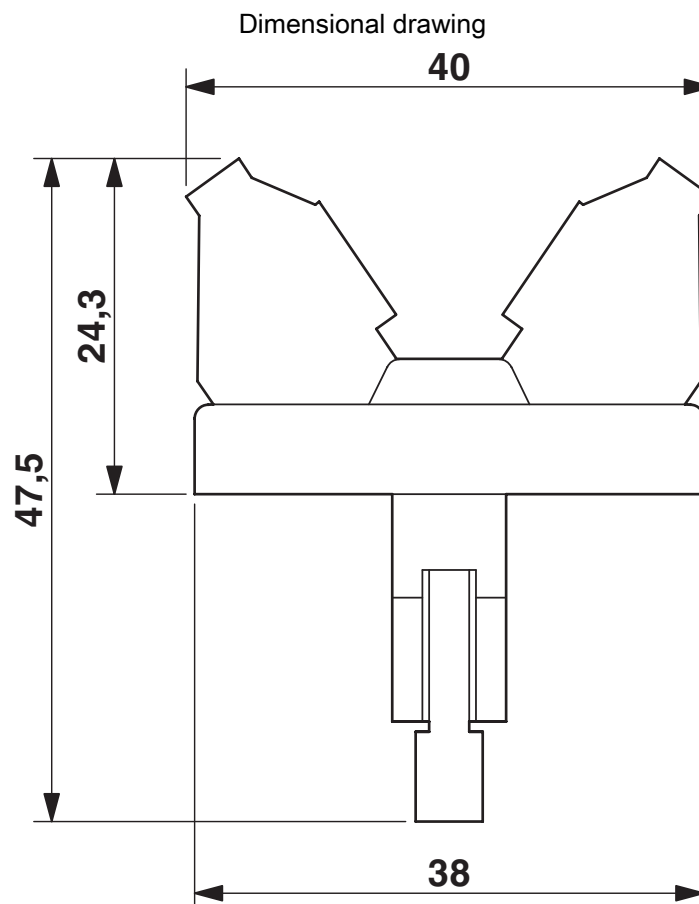
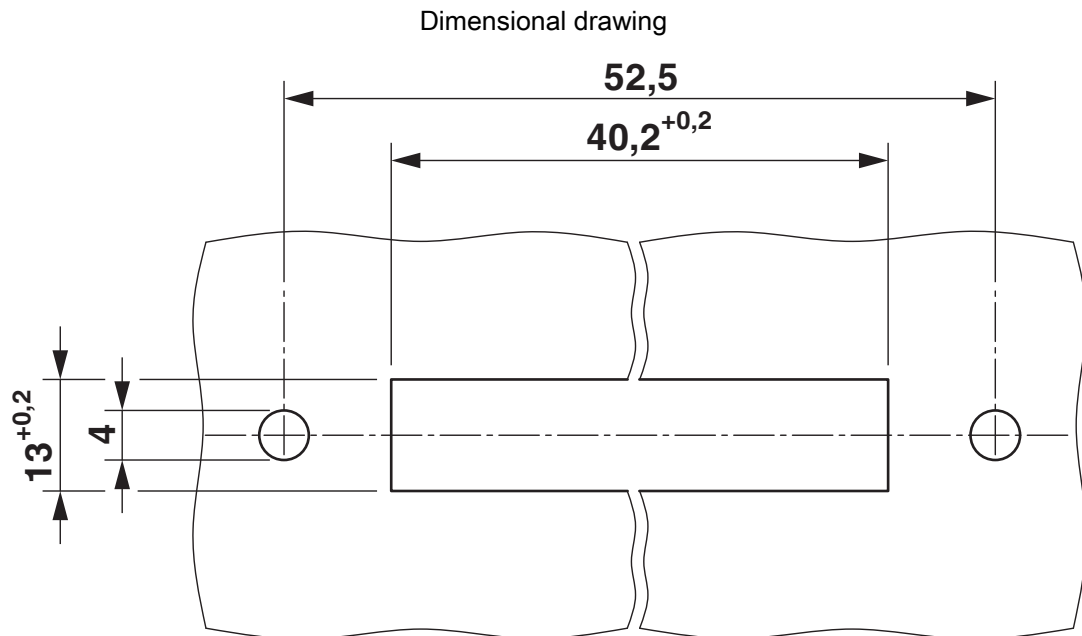

DFLK 50 - Interface module

2280284

<https://www.phoenixcontact.com/us/products/2280284>



Dimensional drawing

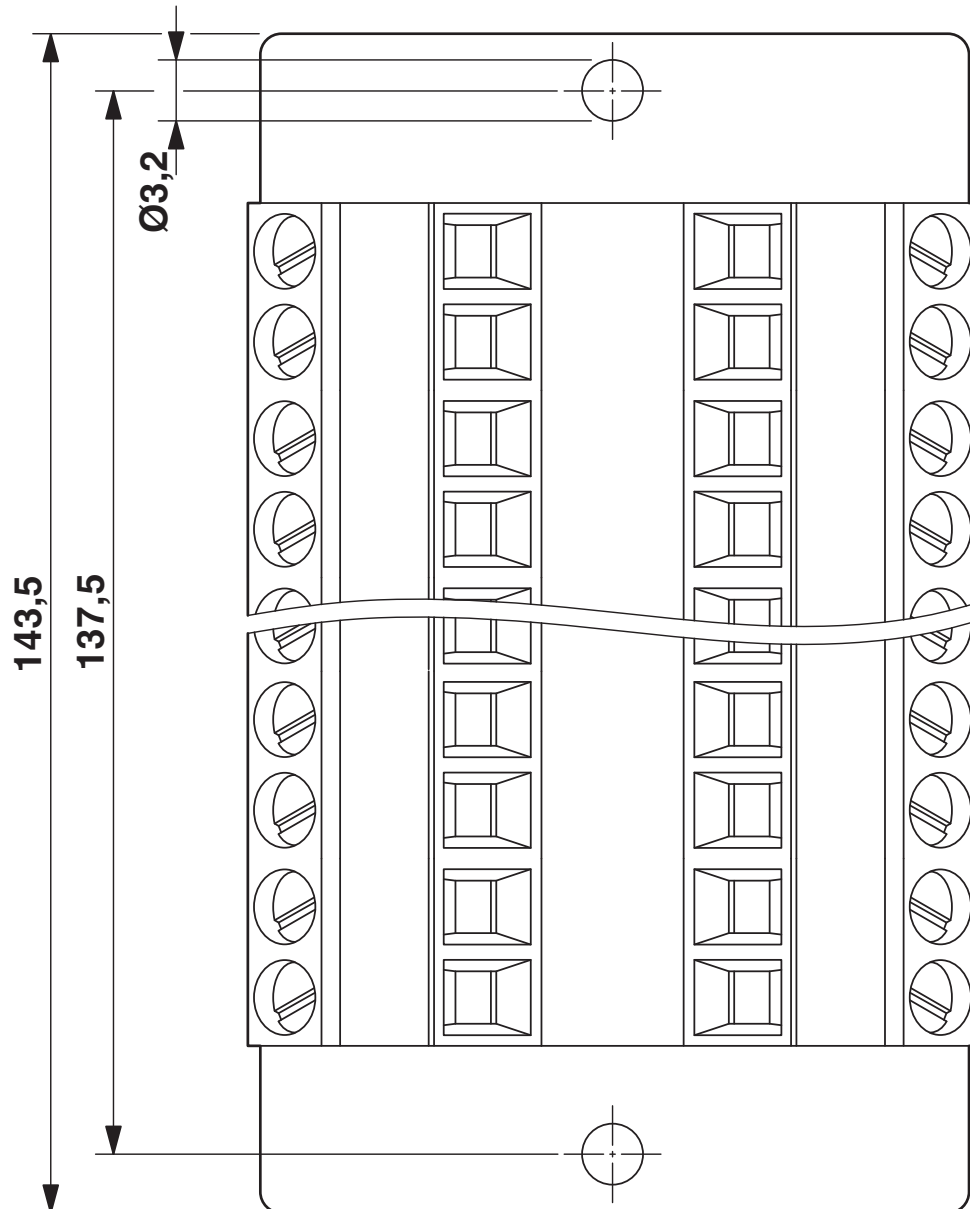

DFLK 50 - Interface module

2280284

<https://www.phoenixcontact.com/us/products/2280284>



Classifications

ECLASS

ECLASS-11.0	27141152
ECLASS-12.0	27141152
ECLASS-13.0	27141152

ETIM

ETIM 9.0	EC002780
----------	----------

UNSPSC

UNSPSC 21.0	39121400
-------------	----------

DFLK 50 - Interface module

2280284

<https://www.phoenixcontact.com/us/products/2280284>



Environmental product compliance

EU RoHS

Fulfills EU RoHS substance requirements	Yes, No exemptions
---	--------------------

China RoHS

Environment friendly use period (EFUP)	EFUP-E
	No hazardous substances above the limits

EU REACH SVHC

REACH candidate substance (CAS No.)	No substance above 0.1 wt%
-------------------------------------	----------------------------

DFLK 50 - Interface module

2280284

<https://www.phoenixcontact.com/us/products/2280284>



Accessories

FLK EZ-DR.../.../... - Cable

2295059

<https://www.phoenixcontact.com/us/products/2295059>

Round cable, with preassembly, not shielded, variable cable length

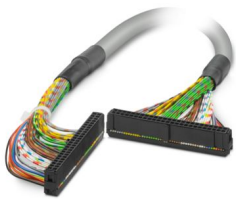

FLK EZ-DR-S.../.../... - Cable

2295046

<https://www.phoenixcontact.com/us/products/2295046>

Round cable, with preassembly, shielded, variable cable length



DFLK 50 - Interface module

2280284

<https://www.phoenixcontact.com/us/products/2280284>



FLK 50/EZ-DR/ 50/KONFEK - Cable

2289065

<https://www.phoenixcontact.com/us/products/2289065>

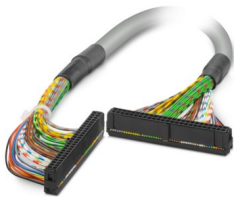

Round cable set; connection 1: IDC/FLK socket strip (1x 50-position); connection 2: IDC/FLK socket strip (1x 50-position); cable length: 0.5 m

FLK 50/EZ-DR/ 100/KONFEK - Cable

2289078

<https://www.phoenixcontact.com/us/products/2289078>



Round cable set; connection 1: IDC/FLK socket strip (1x 50-position); connection 2: IDC/FLK socket strip (1x 50-position); cable length: 1 m

DFLK 50 - Interface module

2280284

<https://www.phoenixcontact.com/us/products/2280284>



FLK 50/EZ-DR/ 150/KONFEK - Cable

2289081

<https://www.phoenixcontact.com/us/products/2289081>



Round cable set; connection 1: IDC/FLK socket strip (1x 50-position); connection 2: IDC/FLK socket strip (1x 50-position); cable length: 1.5 m

FLK 50/EZ-DR/ 200/KONFEK - Cable

2289094

<https://www.phoenixcontact.com/us/products/2289094>

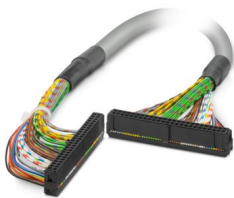

Round cable set; connection 1: IDC/FLK socket strip (1x 50-position); connection 2: IDC/FLK socket strip (1x 50-position); cable length: 2 m

DFLK 50 - Interface module

2280284

<https://www.phoenixcontact.com/us/products/2280284>



FLK 50/EZ-DR/ 250/KONFEK - Cable

2289104

<https://www.phoenixcontact.com/us/products/2289104>



Round cable set; connection 1: IDC/FLK socket strip (1x 50-position); connection 2: IDC/FLK socket strip (1x 50-position); cable length: 2.5 m

FLK 50/EZ-DR/ 300/KONFEK - Cable

2289117

<https://www.phoenixcontact.com/us/products/2289117>

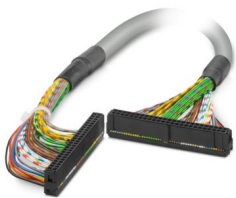

Round cable set; connection 1: IDC/FLK socket strip (1x 50-position); connection 2: IDC/FLK socket strip (1x 50-position); cable length: 3 m

DFLK 50 - Interface module

2280284

<https://www.phoenixcontact.com/us/products/2280284>



FLK 50/EZ-DR/ 350/KONFEK - Cable

2289120

<https://www.phoenixcontact.com/us/products/2289120>



Round cable set; connection 1: IDC/FLK socket strip (1x 50-position); connection 2: IDC/FLK socket strip (1x 50-position); cable length: 3.5 m

FLK 50/EZ-DR/ 400/KONFEK - Cable

2289133

<https://www.phoenixcontact.com/us/products/2289133>



Round cable set; connection 1: IDC/FLK socket strip (1x 50-position); connection 2: IDC/FLK socket strip (1x 50-position); cable length: 4 m

DFLK 50 - Interface module

2280284

<https://www.phoenixcontact.com/us/products/2280284>



FLK 50/EZ-DR/ 450/KONFEK - Cable

2289573

<https://www.phoenixcontact.com/us/products/2289573>



Round cable set; connection 1: IDC/FLK socket strip (1x 50-position); connection 2: IDC/FLK socket strip (1x 50-position); cable length: 4.5 m

FLK 50/EZ-DR/ 500/KONFEK - Cable

2289586

<https://www.phoenixcontact.com/us/products/2289586>

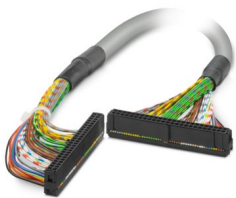

Round cable set; connection 1: IDC/FLK socket strip (1x 50-position); connection 2: IDC/FLK socket strip (1x 50-position); cable length: 5 m

DFLK 50 - Interface module

2280284

<https://www.phoenixcontact.com/us/products/2280284>



FLK 50/EZ-DR/ 550/KONFEK - Cable

2289599

<https://www.phoenixcontact.com/us/products/2289599>



Round cable set; connection 1: IDC/FLK socket strip (1x 50-position); connection 2: IDC/FLK socket strip (1x 50-position); cable length: 5.5 m

FLK 50/EZ-DR/ 600/KONFEK - Cable

2289609

<https://www.phoenixcontact.com/us/products/2289609>



Round cable set; connection 1: IDC/FLK socket strip (1x 50-position); connection 2: IDC/FLK socket strip (1x 50-position); cable length: 6 m

DFLK 50 - Interface module

2280284

<https://www.phoenixcontact.com/us/products/2280284>



FLK 50/EZ-DR/ 700/KONFEK - Cable

2289625

<https://www.phoenixcontact.com/us/products/2289625>



Round cable set; connection 1: IDC/FLK socket strip (1x 50-position); connection 2: IDC/FLK socket strip (1x 50-position); cable length: 7 m

FLK 50/EZ-DR/ 750/KONFEK - Cable

2289638

<https://www.phoenixcontact.com/us/products/2289638>

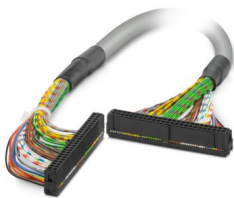

Round cable set; connection 1: IDC/FLK socket strip (1x 50-position); connection 2: IDC/FLK socket strip (1x 50-position); cable length: 7.5 m

DFLK 50 - Interface module

2280284

<https://www.phoenixcontact.com/us/products/2280284>



FLK 50/EZ-DR/ 800/KONFEK - Cable

2289641

<https://www.phoenixcontact.com/us/products/2289641>



Round cable set; connection 1: IDC/FLK socket strip (1x 50-position); connection 2: IDC/FLK socket strip (1x 50-position); cable length: 8 m

FLK 50/EZ-DR/ 850/KONFEK - Cable

2289654

<https://www.phoenixcontact.com/us/products/2289654>



Round cable set; connection 1: IDC/FLK socket strip (1x 50-position); connection 2: IDC/FLK socket strip (1x 50-position); cable length: 8.5 m

DFLK 50 - Interface module

2280284

<https://www.phoenixcontact.com/us/products/2280284>



FLK 50/EZ-DR/ 900/KONFEK - Cable

2289667

<https://www.phoenixcontact.com/us/products/2289667>



Round cable set; connection 1: IDC/FLK socket strip (1x 50-position); connection 2: IDC/FLK socket strip (1x 50-position); cable length: 9 m

FLK 50/EZ-DR/1000/KONFEK - Cable

2289683

<https://www.phoenixcontact.com/us/products/2289683>

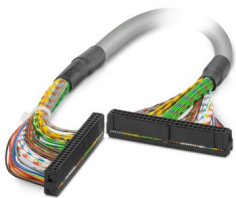

Round cable set; connection 1: IDC/FLK socket strip (1x 50-position); connection 2: IDC/FLK socket strip (1x 50-position); cable length: 10 m

DFLK 50 - Interface module

2280284

<https://www.phoenixcontact.com/us/products/2280284>



FLK 50/EZ-DR/ 125/KONFEK - Cable

2296197

<https://www.phoenixcontact.com/us/products/2296197>



Round cable set; connection 1: IDC/FLK socket strip (1x 50-position); connection 2: IDC/FLK socket strip (1x 50-position); cable length: 1.25 m

FLK 50/EZ-DR/1200/KONFEK - Cable

2296223

<https://www.phoenixcontact.com/us/products/2296223>

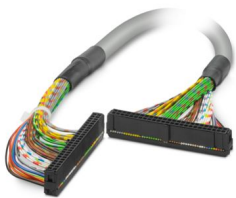

Round cable set; connection 1: IDC/FLK socket strip (1x 50-position); connection 2: IDC/FLK socket strip (1x 50-position); cable length: 12 m

DFLK 50 - Interface module

2280284

<https://www.phoenixcontact.com/us/products/2280284>



FLK 50/EZ-DR/ 50/KONFEK/S - Cable

2299097

<https://www.phoenixcontact.com/us/products/2299097>



Assembled shielded round cable; connection 1: IDC/FLK socket strip (1x 50-position); connection 2: IDC/FLK socket strip (1x 50-position) (The braided shield is routed to a separate cable end.); cable length: 0.5 m

FLK 50/EZ-DR/ 100/KONFEK/S - Cable

2299107

<https://www.phoenixcontact.com/us/products/2299107>



Assembled shielded round cable; connection 1: IDC/FLK socket strip (1x 50-position); connection 2: IDC/FLK socket strip (1x 50-position) (The braided shield is routed to a separate cable end.); cable length: 1 m

DFLK 50 - Interface module

2280284

<https://www.phoenixcontact.com/us/products/2280284>



FLK 50/EZ-DR/ 150/KONFEK/S - Cable

2299110

<https://www.phoenixcontact.com/us/products/2299110>



Assembled shielded round cable; connection 1: IDC/FLK socket strip (1x 50-position); connection 2: IDC/FLK socket strip (1x 50-position) (The braided shield is routed to a separate cable end.); cable length: 1.5 m

FLK 50/EZ-DR/ 200/KONFEK/S - Cable

2299123

<https://www.phoenixcontact.com/us/products/2299123>



Assembled shielded round cable; connection 1: IDC/FLK socket strip (1x 50-position); connection 2: IDC/FLK socket strip (1x 50-position) (The braided shield is routed to a separate cable end.); cable length: 2 m

DFLK 50 - Interface module

2280284

<https://www.phoenixcontact.com/us/products/2280284>



FLK 50/EZ-DR/ 300/KONFEK/S - Cable

2299136

<https://www.phoenixcontact.com/us/products/2299136>



Assembled shielded round cable; connection 1: IDC/FLK socket strip (1x 50-position); connection 2: IDC/FLK socket strip (1x 50-position) (The braided shield is routed to a separate cable end.); cable length: 3 m

FLK 50/EZ-DR/ 400/KONFEK/S - Cable

2299149

<https://www.phoenixcontact.com/us/products/2299149>



Assembled shielded round cable; connection 1: IDC/FLK socket strip (1x 50-position); connection 2: IDC/FLK socket strip (1x 50-position) (The braided shield is routed to a separate cable end.); cable length: 4 m

DFLK 50 - Interface module

2280284

<https://www.phoenixcontact.com/us/products/2280284>



FLK 50/EZ-DR/ 600/KONFEK/S - Cable

2299152

<https://www.phoenixcontact.com/us/products/2299152>



Assembled shielded round cable; connection 1: IDC/FLK socket strip (1x 50-position); connection 2: IDC/FLK socket strip (1x 50-position) (The braided shield is routed to a separate cable end.); cable length: 6 m

FLK 50/EZ-DR/1000/KONFEK/S - Cable

2299178

<https://www.phoenixcontact.com/us/products/2299178>



Assembled shielded round cable; connection 1: IDC/FLK socket strip (1x 50-position); connection 2: IDC/FLK socket strip (1x 50-position) (The braided shield is routed to a separate cable end.); cable length: 10 m

DFLK 50 - Interface module

2280284

<https://www.phoenixcontact.com/us/products/2280284>

CABLE-FLK50/0,14/HF/ 0,5M - Cable

2314134

<https://www.phoenixcontact.com/us/products/2314134>

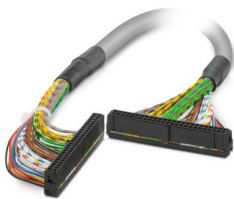

Assembled, halogen-free round cable; connection 1: IDC/FLK socket strip (1x 50-position); connection 2: IDC/FLK socket strip (1x 50-position); cable length: 0.5 m

CABLE-FLK50/0,14/HF/ 1,0M - Cable

2314147

<https://www.phoenixcontact.com/us/products/2314147>



Assembled, halogen-free round cable; connection 1: IDC/FLK socket strip (1x 50-position); connection 2: IDC/FLK socket strip (1x 50-position); cable length: 1 m

DFLK 50 - Interface module

2280284

<https://www.phoenixcontact.com/us/products/2280284>



CABLE-FLK50/0,14/HF/ 1,5M - Cable

2314150

<https://www.phoenixcontact.com/us/products/2314150>

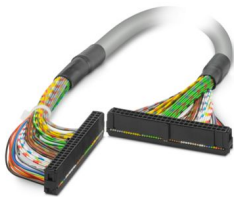

Assembled, halogen-free round cable; connection 1: IDC/FLK socket strip (1x 50-position); connection 2: IDC/FLK socket strip (1x 50-position); cable length: 1.5 m

CABLE-FLK50/0,14/HF/ 2,0M - Cable

2314163

<https://www.phoenixcontact.com/us/products/2314163>



Assembled, halogen-free round cable; connection 1: IDC/FLK socket strip (1x 50-position); connection 2: IDC/FLK socket strip (1x 50-position); cable length: 2 m

DFLK 50 - Interface module

2280284

<https://www.phoenixcontact.com/us/products/2280284>

CABLE-FLK50/0,14/HF/ 2,5M - Cable

2314176

<https://www.phoenixcontact.com/us/products/2314176>

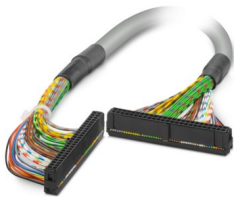

Assembled, halogen-free round cable; connection 1: IDC/FLK socket strip (1x 50-position); connection 2: IDC/FLK socket strip (1x 50-position); cable length: 2.5 m

CABLE-FLK50/0,14/HF/ 3,0M - Cable

2314189

<https://www.phoenixcontact.com/us/products/2314189>



Assembled, halogen-free round cable; connection 1: IDC/FLK socket strip (1x 50-position); connection 2: IDC/FLK socket strip (1x 50-position); cable length: 3 m

DFLK 50 - Interface module

2280284

<https://www.phoenixcontact.com/us/products/2280284>

CABLE-FLK50/0,14/HF/ 4,0M - Cable

2314192

<https://www.phoenixcontact.com/us/products/2314192>



Assembled, halogen-free round cable; connection 1: IDC/FLK socket strip (1x 50-position); connection 2: IDC/FLK socket strip (1x 50-position); cable length: 4 m

CABLE-FLK50/0,14/HF/ 5,0M - Cable

2314202

<https://www.phoenixcontact.com/us/products/2314202>



Assembled, halogen-free round cable; connection 1: IDC/FLK socket strip (1x 50-position); connection 2: IDC/FLK socket strip (1x 50-position); cable length: 5 m

DFLK 50 - Interface module

2280284

<https://www.phoenixcontact.com/us/products/2280284>



CABLE-FLK50/0,14/HF/10,0M - Cable

2314244

<https://www.phoenixcontact.com/us/products/2314244>

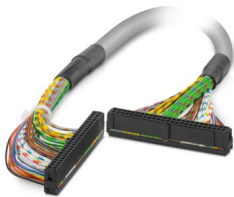

Assembled, halogen-free round cable; connection 1: IDC/FLK socket strip (1x 50-position); connection 2: IDC/FLK socket strip (1x 50-position); cable length: 10 m

CABLE-FLK50-0,14-HF/... - Cable

2314257

<https://www.phoenixcontact.com/us/products/2314257>



Assembled, halogen-free round cable; connection 1: IDC/FLK socket strip (1x 50-position); connection 2: IDC/FLK socket strip (1x 50-position); cable length: variable

Phoenix Contact 2024 © - all rights reserved
<https://www.phoenixcontact.com>

Phoenix Contact USA
586 Fulling Mill Road
Middletown, PA 17057, United States
(+717) 944-1300
info@phoenixcon.com